

DISPLAY AND CROWN OPERATION

《VH60A》

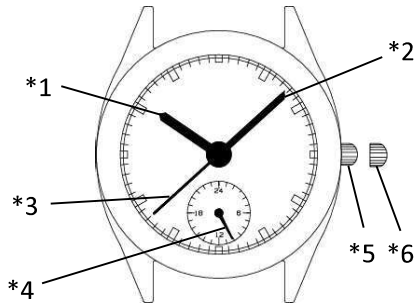

Note:

- *1: Hour hand
- *2: Minute hand
- *3: Second hand
- *4: 24Hour hand
- *5: Crown at normal position
- *6: First click
▪ Time setting

TIME SETTING

《VH60A》

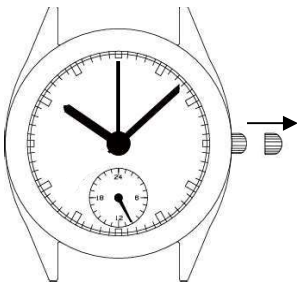

1. pull out the crown to the first click when the second hand is at the 12 O'clock position.

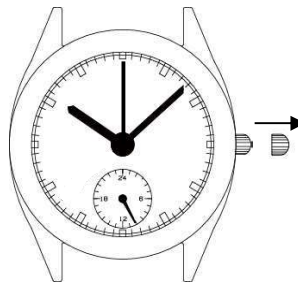

2. Turn the crown to set the hour and minute hands to the time. (Check that AM / PM is set correctly)

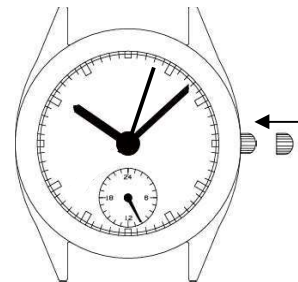

3. Push the crown back in to the normal position in accordance with a time signal.

DISPLAY AND CROWN OPERATION

《VH61A》

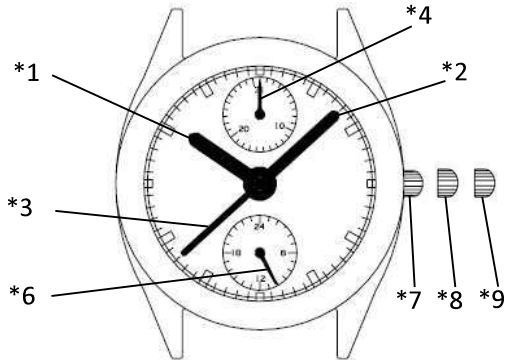

《VH63A》

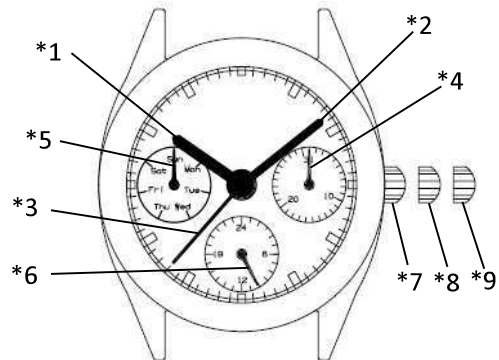

《VH64A》

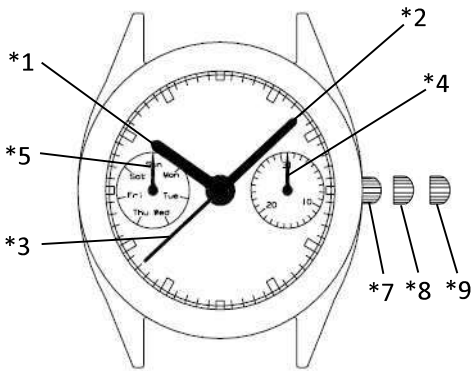

《VH65A》

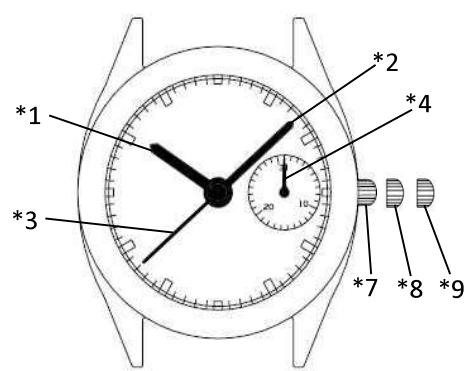

《VH67A》

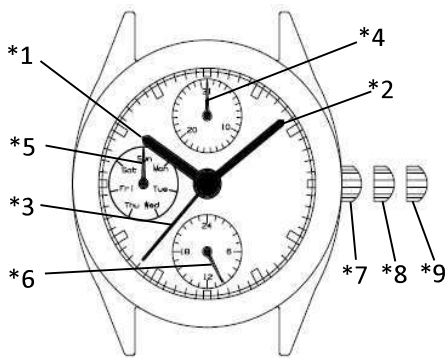

《VH68A》

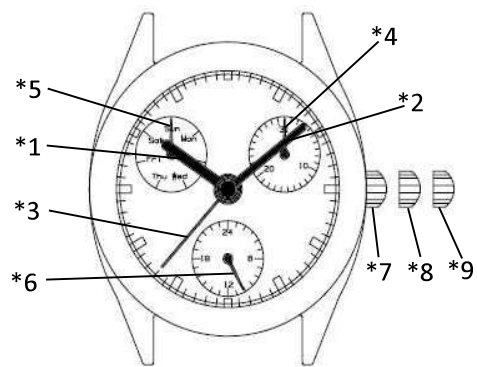

Note:

- | | | | |
|-----------------|------------------------|--|------------------|
| *1: Hour hand | *4: Date calendar hand | *7: Crown at normal position | *9: Second click |
| *2: Minute hand | *5: Day calendar hand | *8: First click | • Time setting |
| *3: Second hand | *6: 24 Hour hand | • Date setting (Quick change function) | |

TIME SETTING
《VH61A/VH63A/VH64A/VH65A/VH67A/VH68A》

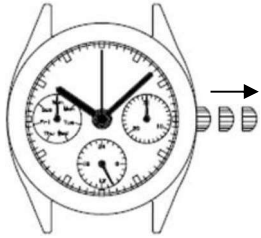

1.Pull out the crown to the second click when the second hand is at the 12 O'clock position.

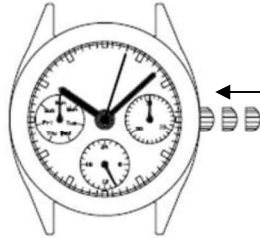

2.Push the crown back into the normal position in signal.

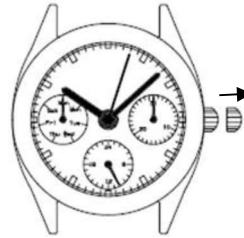

3.Pull out the crown to the first click.
Turn the crown counter-clockwise to set the date.

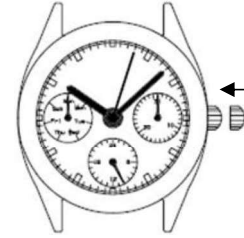

4.Push the crown back into the normal position.

Turn the crown rotation to set the day of the week.

Turn the crown to set the hour and minute hands to the time.

(Check that AM / PM is set correctly)

*Do not set the date between 10:00 PM and 2:00 AM

Otherwise, the day may not change properly. If it is necessary to set the date during that time period, first change the time to any time outside it and set the date, and then reset the correct time.