

RONDA startech 5000

Chronographs, Big Date & Date,
different calendar systems, Alarm

Caliber 5040.F – 12½'''

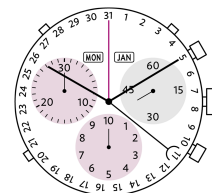
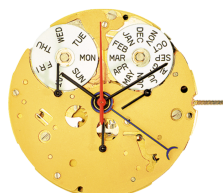
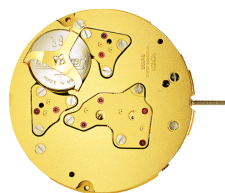

Product Specifications

Analog quartz movement	
Line	startech
Caliber	5040.F
Size	12½'''
Version	Swiss Made
	13 Jewels / gold plated
Standard battery life	54 months
Hand fitting height	3

Features

- Very long battery life
- Repairable metal watch movement
- Power saving mechanism with pulled out stem: Reduction of consumption approximately 70%
- Very easy handling by two pushers

Functions

- Chronograph
- Center stop second (1/1 sec)
- 1/10 second
- 1/10 seconds up to 30 minutes
- 30 minute counter
- 10 hour counter
- ADD and SPLIT functions
- 3 eyes
- Day indicator
- Small second
- Month indicator
- Date
- Date by hand

Technical Specifications

Diameter Total	28.60 mm
Case fitting	28.00 mm
Movement height	4.40 mm
Height over standard battery	4.40 mm
Movement rest	0.60 mm
Height over stem	1.90 mm
Length of stem travel	0.90 mm
Stem thread	0.90 mm
Standard battery	395
Standard battery life	54 months
Battery voltage	1.5 V
Current consumption – typical	1.32 µA (Date Mechanism not in Gear)
Current consumption – maximum	1.65 µA (Date Mechanism not in Gear)
Useful torque second – typical	6 µNm
Useful torque minute – typical	300 µNm
Useful torque center stop second – typical	7 µNm
Operating temperature	0 - 50 °C
Instantaneous rate	-10/ +20 sec/month
Resistance to magnetic fields	18.8 Oe
Resistance against shock	NIHS 91-10



Detail zu Drücker A

Detail zu Korrektor D + E

Angle poussoir A Winkel Drücker A Angle pusher A			15°
Ø Dp	a	b	
1.30	3.83	12.92	
1.40	3.86	12.91	

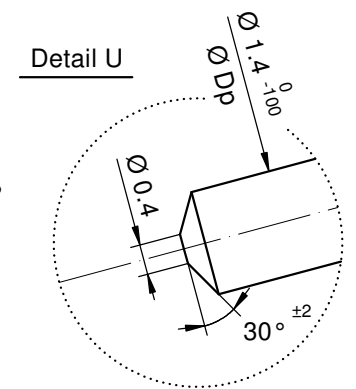
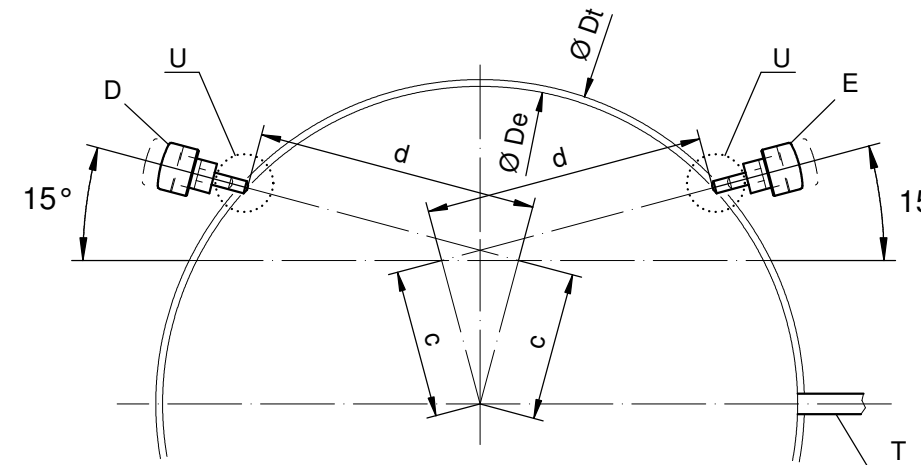
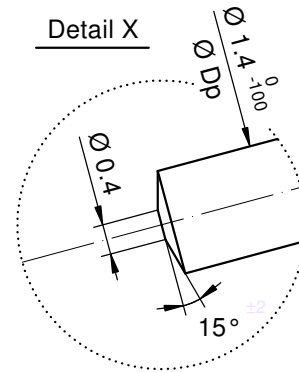
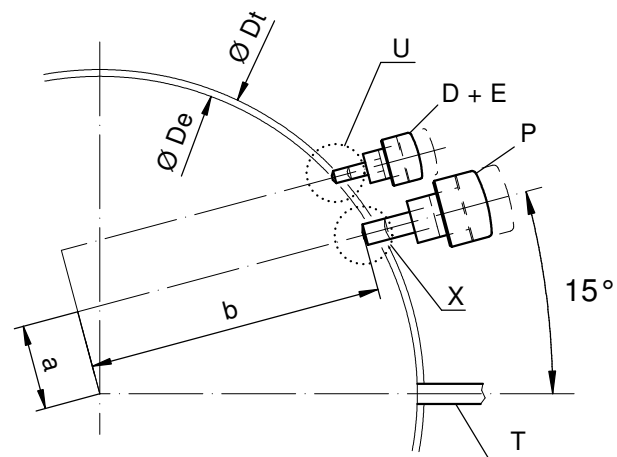

Angle poussoir A Winkel Drücker A Angle pusher A			10°
Ø Dp	a	b	
1.30	5.06	12.52	
1.40	5.10	12.50	

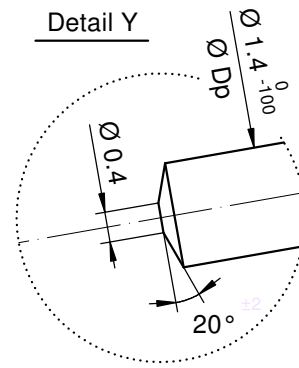
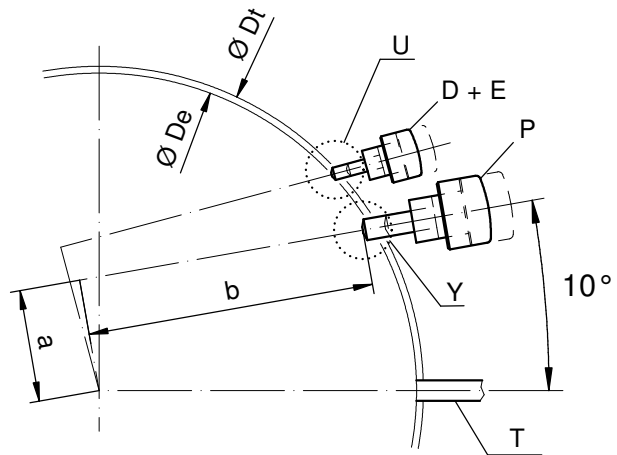

Angle correcteur D Winkel Korrektor D Angle crrector D		
Ø Dp	c	d
1.30	7.27	11.16
1.40	7.27	11.15

Angle correcteur E Winkel Korrektor E Angle crrector E		
Ø Dp	c	d
1.30	7.27	11.46
1.40	7.27	11.45

Ø De: diamètre d'encageage
Durchmesser der Gehäusepassung
fitting-diameter

Ø Dp: diamètre du poussoir
Drückerdurchmesser
pusher-diameter

Ø Dt: diamètre total
Totaldurchmesser
total-diameter

P: poussoir en position poussée
Drücker in gedrückter Stellung
pusher in pressed position

T: tige de mise à l'heure
Stellwelle
stem

Angle poussoir A Winkel Drücker A Angle pusher A			0°
Ø Dp	a	b	
1.30	7.40	11.43	
1.40	7.45	11.40	

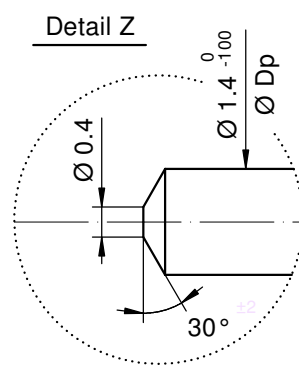
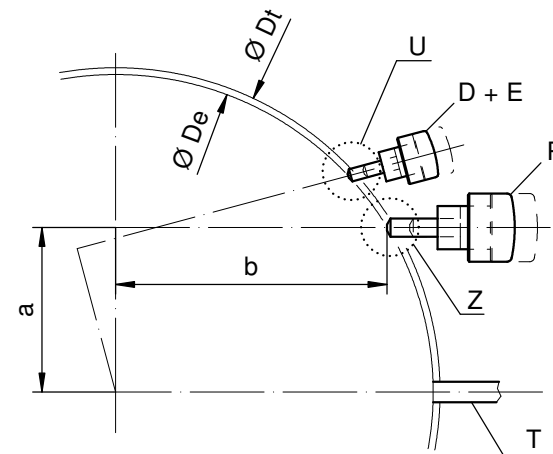

Angle des correcteurs D+E & poussoir A
Winkel der Korrektoren D+E & Drücker A
Angle of correctors D+E & pusher A

Issued	23 Jun 2009	ps
Modified	17 Mai 2013 ÄÄ 13305	mc
Released	YES	
Tolerance	+/- 20 µm	
Scale	10 : 1 (5 : 1) (A3H)	

RONDA 5040.F

Sous réserve de modifications Änderungen vorbehalten Modifications reserved		
No.	5000.386	01

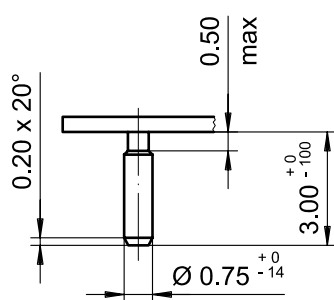
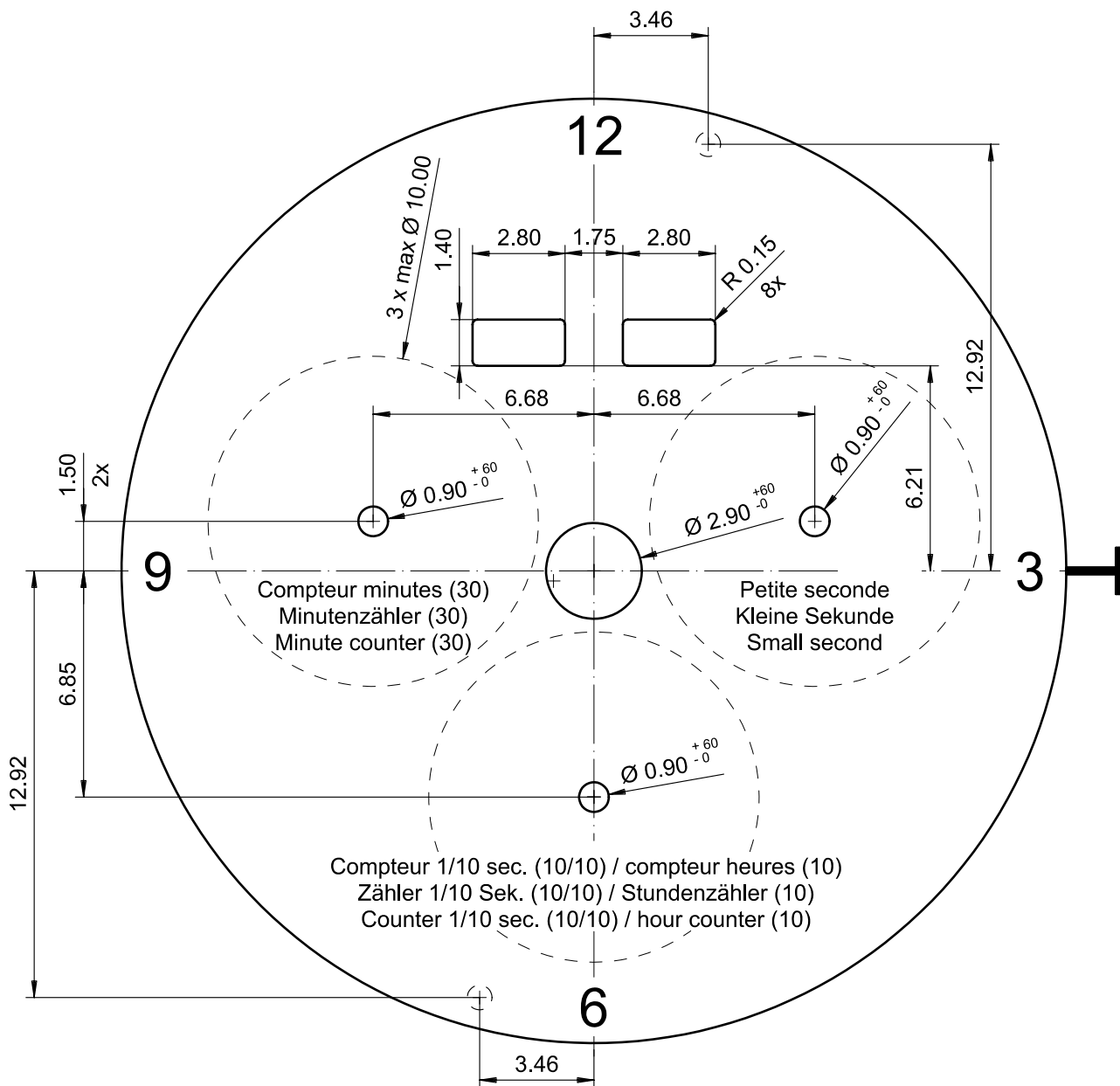

Epaisseur du cadran selon hauteur de l'aiguillage
 Zifferblattdicke gemäss Zeigerwerkhöhen
 Dial thickness according to hand fitting heights

Tige	Jour	Mois
Stellw.	Tag	Monat
Stem	Day	Month
3H	12H	12H

Cadran
 Zifferblatt
 Dial

12 1/2"

Issued	13 Dez 2006	cw
Modified	08.Mai 2007 ÄA 1974	cm
Released	YES	
Tolerance	+/- 20 µm	
Scale	5 : 1 (A4V)	

RONDA

5040.F

Sous réserve de modifications
 Aenderungen vorbehalten
 Modifications reserved

No. 5010.730 02

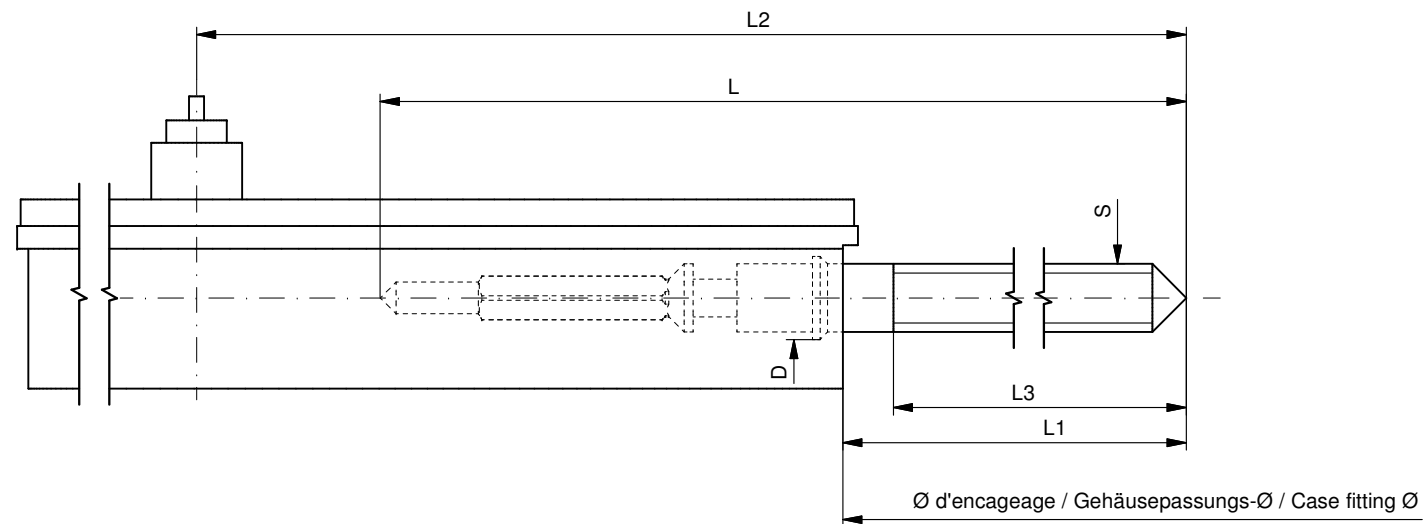

Tige de travail (intégrée dans le mouvement)
 Arbeitstellwelle (im Werk eingebaut)
 Working stem (implemented in the movement)

No. d'article Artikelnummer Part number	L	L1	L2	L3	S	D
3000.177.CO	20.00	10.23	24.23	10.15	0.90	1.10

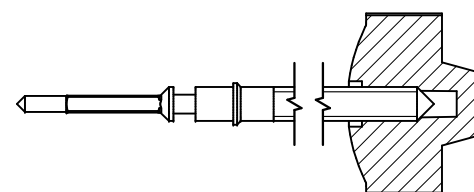

Couleur de la couronne Kronenfarbe Crown color	bleu foncé dunkelblau dark blue
Code	UN 5002

Tige (normale) / Stellwelle (normal) / Stem (normal)

No. d'article Artikelnummer Part number	L	L1	L2	L3	S	D
3000.177	20.00	10.23	24.23	10.15	0.90	1.10
3000.191	32.00	22.23	36.23	22.15	0.90	1.10

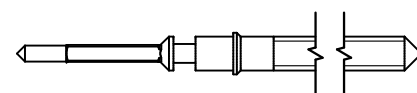

Couronne normale
 Normale Krone
 Normal crown

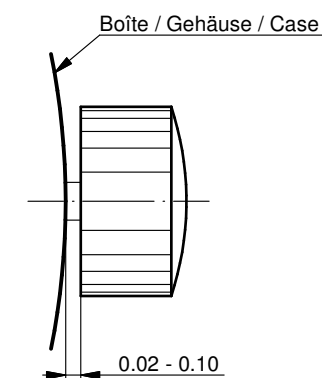

Couronne vissée
 Geschraubte Krone
 Screwed crown

Force ⇐ min. Kraft ⇐ min. Force ⇐ min.	10 N
Force ⇐ max. Kraft ⇐ max. Force ⇐ max.	15 N

Rallonge de tige / Stellwelle Verlängerung / Stem extension

No. d'article Artikelnummer Part number	L4	L5 (min)	L6	S1	S2	D1
3000.040	12.00	1.90	2.60	0.90	0.90	1.35

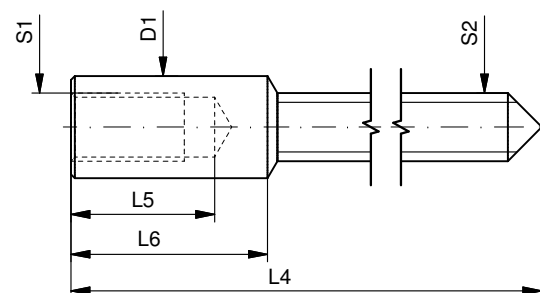

Tige (dimensions / forces)
 Stellwelle (Dimensionen / Kräfte)
 Stem (dimensions / forces)

RONDA

5010.B, 5020.B, 5021.D, 5030.D,
 5040.B, 5040.D, 5040.E, 5040.F,
 5050.B, 5050.C, 5051.C, 5130.B, 5130.D

Issued	05 Sep 2012	ds5222
Modified	17 Mär 2017 ÄA 34582	mg5224
Released	YES	
Tolerance	---	
Scale	10:1 (A3)	

Sous réserve de modifications
 Änderungen vorbehalten
 Modifications reserved

No.	5030.019	01
-----	----------	----

RONDA startech – Movement Cal. 5040.F

User's Manual English

You have decided to buy a watch, which was assembled by a watchmaker using a Ronda movement. Please note that no watches are produced or distributed under the Ronda Brand.

In case of repairs, guarantee claims and questions concerning the functioning of a watch, purchasers and consumers should contact their retailer or the watch manufacturer, for which the relevant information can be found in the sales or guarantee documentation provided with the watch.

Description of the display and control buttons

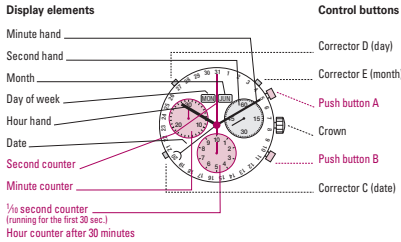

01

Chronograph: Basic function

(Start / Stop / Reset)

Example:

1 **Start:** Press push-button A.

2 **Stop:** to stop the timing, press push-button A once more and read the chronograph counters:
4 min / 38 sek / 7/8 sec

3 **Zero positioning:** Press push-button B. (The chronograph hands will be reset to their zero positions.)

05

Chronograph: Accumulated timing

Example:

1 **Start:** (start timing)

2 **Stop:** (e.g. 15 min 5 sec following 1)

3 **Restart:** (timing is resumed)

4 **Stop:** (e.g. 5 min 12 sec following 3)
= 20 min 17 sec
(The accumulated measured time is shown)

5 **Reset:** The chronograph hands are returned to their zero positions.

Please note:

* Following 4, the accumulation of the timing can be continued by pressing push-button A (Restart / Stop, Restart / Stop, ...).

06

Setting the time

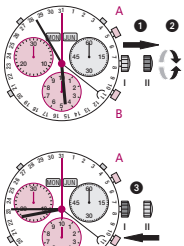

1* Pull out the crown to position II (the watch stops).

2 Turn the crown until you reach the correct time 8.45.

3* Push the crown back into position I.

Please note:

* In order to set the time to the exact second, 1 must be pulled out when the second hand is in position «60». Once the hour and minute hands have been set, 3 must be pushed back into position I at the exact second.

02

Chronograph: Intermediate or interval timing

Example:

1 **Start:** (start timing)

2 **Display interval:** (e.g. 20 minutes 17 seconds (timing continues in the background))

3 **Making up the measured time:** (The chronograph hands are quickly advanced to the ongoing measured time.)

4 **Stop:** (Final time is displayed.)

5 **Reset:** The chronograph hands are returned to their zero position

Please note:

* Following 4, further intervals or intermediates can be measured by pressing push-button B (display interval / make up measured time, ...).

07

Setting the date (quick mode)

Example after a change of month:

- Date on watch: 31

- Current date: 1

1 Press the corrector C once to adjust the date 1 day forward.

Please note:

The date for the following day must be set during the date changing phase between approx 9:00 PM and 00:20 AM.

03

Adjusting the chronograph hands to zero position

Example:

One or several chronograph hands are not in their correct zero positions and have to be adjusted (e.g. following a battery change).

1 Pull out the crown to position II (all chronograph hands are in their correct or incorrect zero position).

2 Keep push-buttons A and B depressed simultaneously for at least 2 seconds (the second counter hand rotates by 360° → corrective mode is activated).

Setting the time, date, day of week and month

Example:

- On the watch: 10 JAN 1:25 AM

- Current: 20 FEB 8:30 PM

1* Pull out the crown to position II (the watch stops).

2** Turn crown until the current time is shown.

3* Push crown to position I (watch continues to run).

4 Press the corrector C to gradually advance the date hand.

5 Press the corrector D to gradually advance the day of week.

6 Press the corrector E to gradually advance the month.

Please note:

* To set your watch to the exact second please refer to the chapter entitled «Setting the time»

** Please observe the AM/PM clock rhythm

04

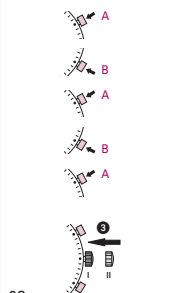

Adjusting the second counter hand

Single step: A 1 x short
Continuous: A long

Adjusting the next hand B

Single step: A 1 x short
Continuous: A long

Adjusting the 1/2 second counter hand (position 6h)

Single step: A 1 x short
Continuous: A long

Adjusting the next hand B

Single step: A 1 x short
Continuous: A long

Adjusting the minute counter (position 9h)

Single step: A 1 x short
Continuous: A long

3 Returning the crown to position I

Termination of the chronograph hands adjustment (can be carried out at any time).

08



Battery type: 395 / SR927SW
Accuracy: +20 / -10 seconds per month

07/2017



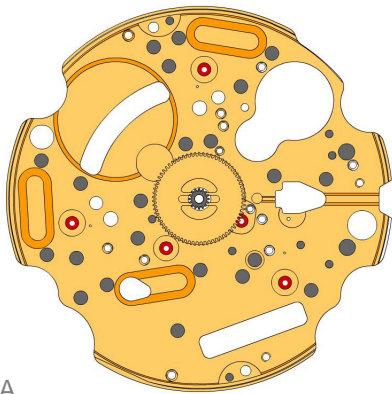



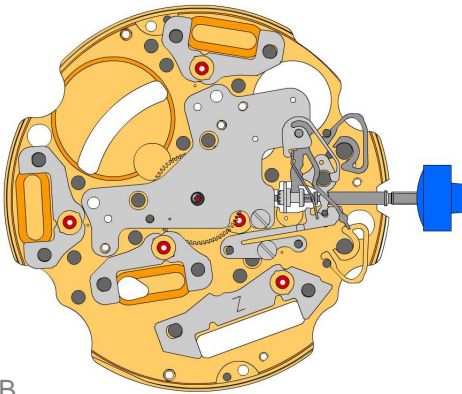















A

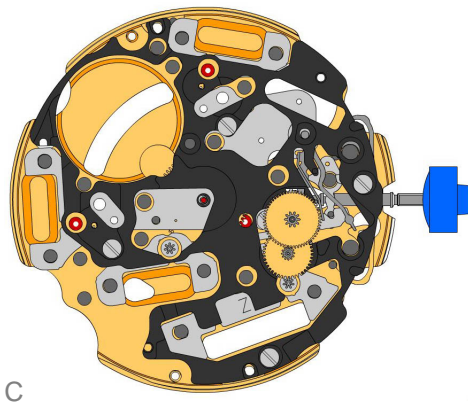





B

2000.576 1.		Main plate Parts 2000.576, 3015.072 and 3905.058 must be exchanged together.
3305.287.CO 2.		Canon pinion with driver (Aig.3)
2030.017.CO 3.		Centre bridge Centre bridge held by 1 screw 4000.250. Parts 2030.017.CO and 3402.009.CO must be exchanged together.
4000.250 4.		Screw
3001.045 5.		Sliding pinion
3000.177.CO 6.		Setting stem
3017.049 7.		Setting lever
3905.053 8.		Setting lever jumper (2 positions) Setting lever jumper held by 1 screw 4000.250.
4000.250 9.		Screw
3015.072 10.		Yoke (2 positions) Parts 2000.576, 3015.072 and 3905.058 must be exchanged together.
3905.058 11.		Yoke spring Tensioning the spring arm. Parts 2000.576, 3015.072 and 3905.058 must be exchanged together.
3406.030 12.		Pusher jumper B Put the grey jumper between the two posts on the further side.
3406.038 13.		Pusher jumper A Put the yellow jumper between the two posts on the closer side.
3622.040 14.		Stator Mark [Z] on stator.
3622.039 15.		Stator (counter 6h, 9h, chrono)
3622.039 16.		Stator (counter 6h, 9h, chrono)
3622.039 17.		Stator (counter 6h, 9h, chrono)

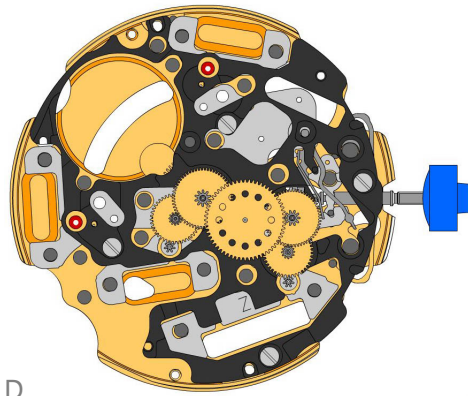





3603.079 18.		Plastic bracket Plastic bracket held by 4 screws 4000.250.
4000.250 19.		Screw
3715.094.RK 20.		Rotor
3715.094.RK 21.		Rotor
3147.046.CO 22.		Intermediate wheel
3136.142.CO 23.		Second wheel (long)

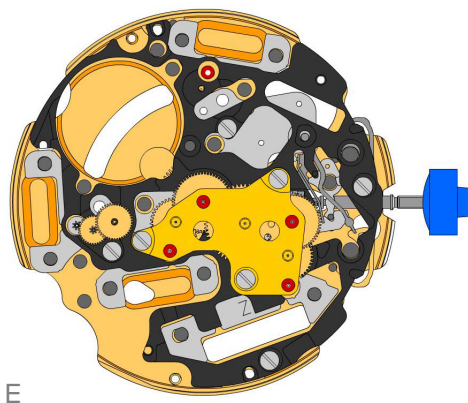





3147.047.CO 24.		Intermediate wheel (chrono)
3136.150.CO 25.		Chronograph wheel (Aig.3)
3122.056.CO 26.		Third wheel

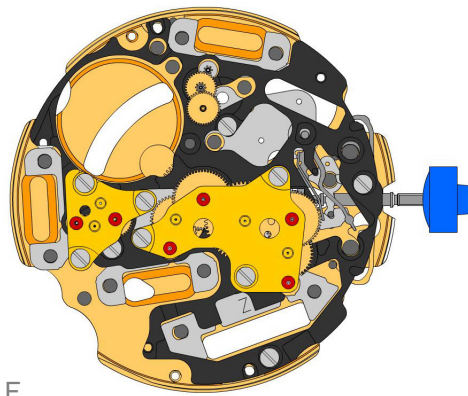

2020.148.G 27.		Train wheel bridge Train wheel bridge held by 3 screws 4000.250.
4000.250 28.		Screw
3715.095.RK 29.		Rotor
3147.048.CO 30.		Intermediate wheel (counter)
3402.006.CO 31.		Minute counting wheel







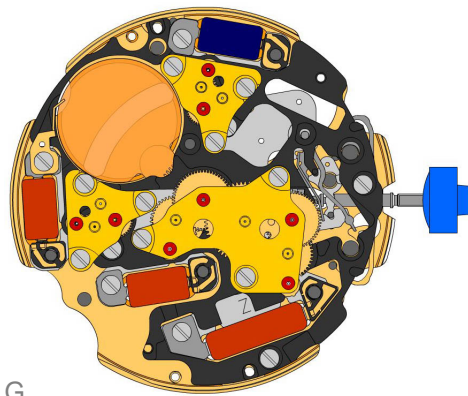





F

2020.149.G 32.		Counter train wheel bridge Counter train wheel bridge held by 3 screws 4000.250.
4000.250 33.		Screw
3715.095.RK 34.		Rotor
3147.053.CO 35.		Intermediate wheel (counter 1/10sec)
3402.009.CO 36.		Counting wheel 1/10 sec Parts 2030.017.CO and 3402.009.CO must be exchanged together.





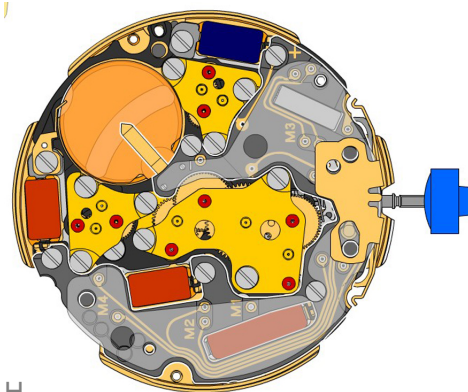

G

2020.149.G 37.		Counter train wheel bridge Counter train wheel bridge held by 3 screws 4000.250.
4000.250 38.		Screw
3621.053.RK 39.		Coil Attention: Please hold the coil only on the grey coil core. Coil held by 1 screw 4000.250.
3621.054.RK 40.		Coil (counter 9h, chrono) Attention: Please hold the coil only on the grey coil core. Coil held by 1 screw 4000.250.
3621.054.RK 41.		Coil (counter 9h, chrono) Attention: Please hold the coil only on the grey coil core. Coil held by 1 screw 4000.250.
3621.055.RK 42.		Coil (counter 6h) Attention: Please hold the coil only on the grey coil core. Coil held by 1 screw 4000.250.
4000.250 43.		Screw
3601.118 44.		Contact strip Contact strip held by 1 screw 4000.250.
4000.250 45.		Screw
3603.034 46.		Battery insulator



H

3612.144.5040 47.		Electronic module Electronic module held by 5 screws 4000.248. Electronic measurements may be realised now.
4000.248 48.		Screw
3603.069 49.		Circuit insulator
3601.107.G 50.		Pusher contact spring

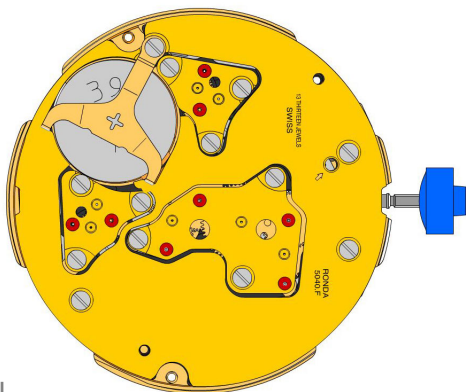

2130.137.G.M01.5040F
51.  **Electronic module cover**
Electronic module cover held by 3 screws 4000.250.



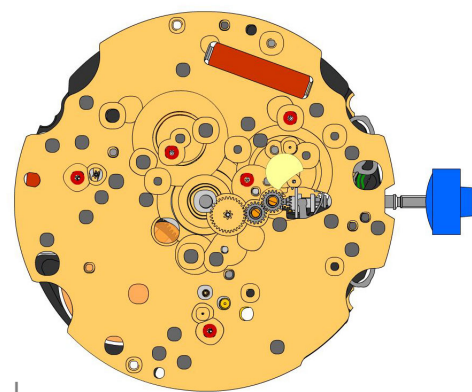

3600.010.HGF
52.  **Battery 395**

3601.109.G
53.  **Bridge +**
Bridge held by 1 screw 4000.250.

4000.250
54.  **Screw**





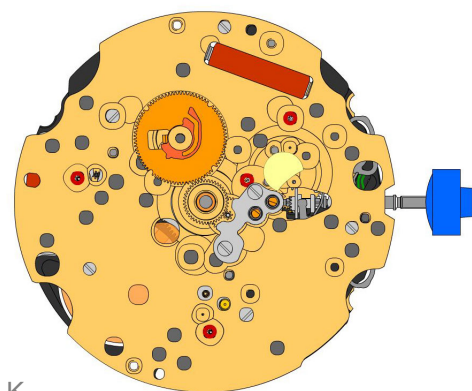

J

2000.576 55.		Main plate
3004.164 56.		Setting wheel
3004.164 57.		Setting wheel
3007.078.CO 58.		Minute wheel



K



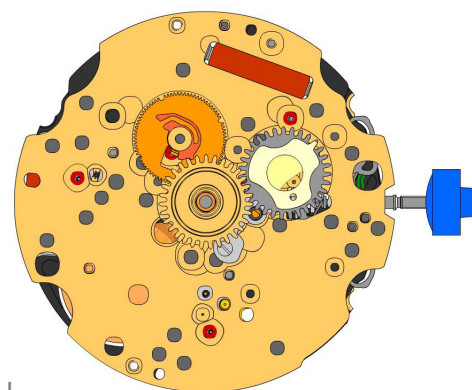





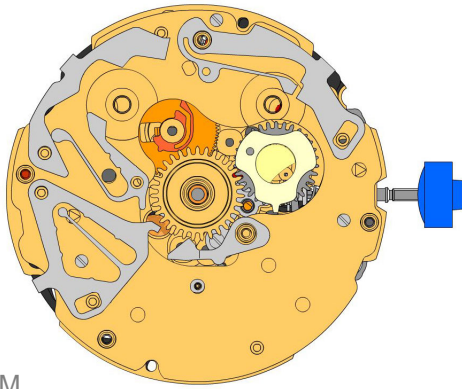
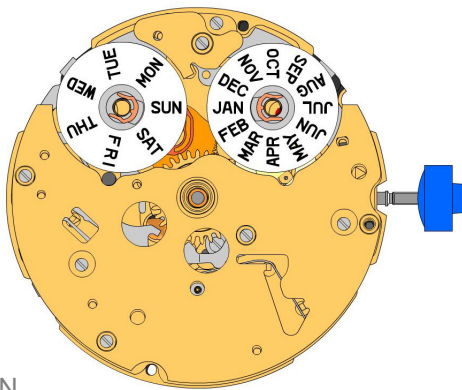







2130.177 59.		Minute train bridge Minute train bridge held by 4 screws 4000.319.
4000.319 60.		Screw
3301.247 61.		Hour wheel (Aig.3)
3004.171.CO 62.		Date indicator driving wheel







L

3004.173 63.		Month driving wheel
3004.174 64.		Month finger Ridges at the bottom side from the month meshed in both gaps of the month driving wheel.
3301.248 65.		Date indicator wheel



M

N

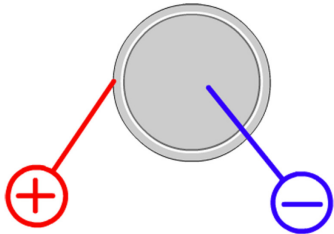
2130.155.CO 66.		Date platform Date platform held by 3 screws 4000.282.
4000.282 67.		Screw
3507.054 68.		Month corrector
3507.055 69.		Day corrector
3507.056 70.		Date corrector
3500.053 71.		Day jumper
3500.065 72.		Date jumper
2130.157.G 73.		Combined maintaining plate Combined maintaining plate held by 4 screws 4000.286.
4000.286 74.		Screw
2130.166.G 75.		Corrector maintaining plate Corrector maintaining plate held by 1 screw 4000.286.
4000.286 76.		Screw
3905.059 77.		Date jumper spring Insert the date jumper spring in the provided opening.
3508.153.AA.E.A 78.		Day indicator (standard)
3508.154.AE.E.A 79.		Month indicator (standard)
3909.028 80.		Pillar spring clip
3909.028 81.		Pillar spring clip

8200 82.		Moebius 8200
9014 83.		Moebius 9014
124 84.		Jismaa 124
9020 85.		Moebius 9020

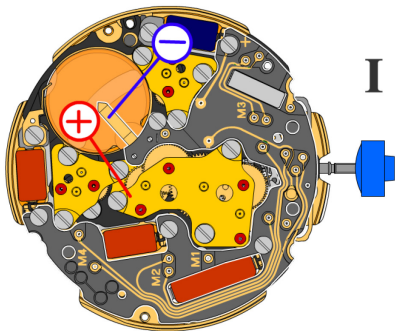

Battery	395
Voltage	1.55 V



*Setting stem in position I, calendar not in gear,
60 s measuring interval for rate and consumption:*

Typical consumption	1.32 μA
Maximal consumption	1.65 μA
Rate	-10s/M. .. +20s/M.
Lower working voltage limit	1.20 V

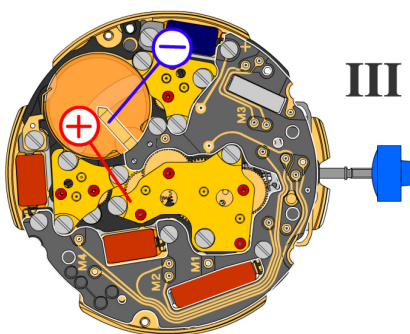

Setting stem in position III, 60 s measuring interval:

Typical consumption	0.10 μA
Maximal consumption	0.30 μA

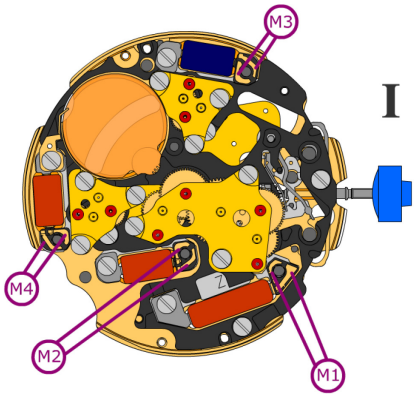

Coil resistance M1 **1.90 kΩ .. 2.10 kΩ**

Coil resistance M2 **1.68 kΩ .. 1.88 kΩ**

Coil resistance M3 **1.68 kΩ .. 1.88 kΩ**

Coil resistance M4 **1.68 kΩ .. 1.88 kΩ**

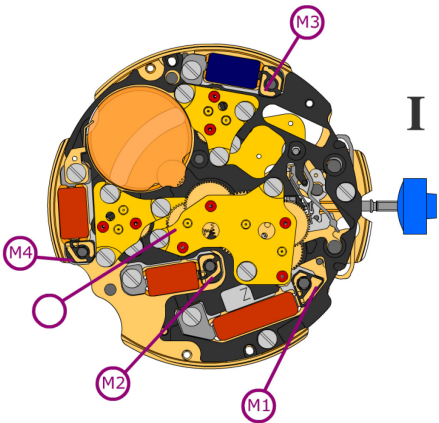

Coil isolation M1/M2/M3/M4 **∞ kΩ**

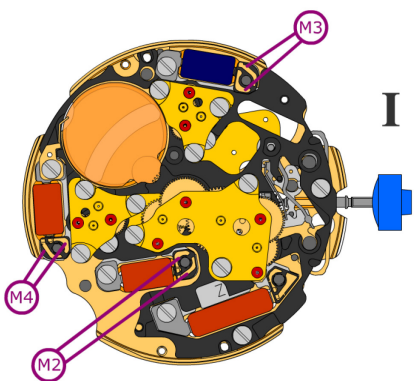

Signal generator (4.9 ms, 8 Hz):



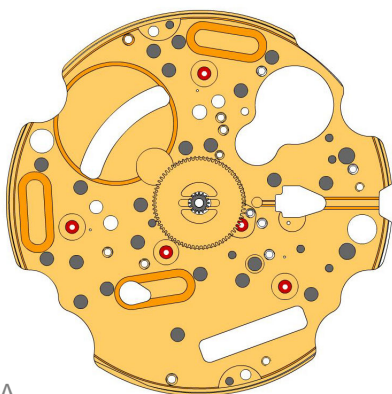



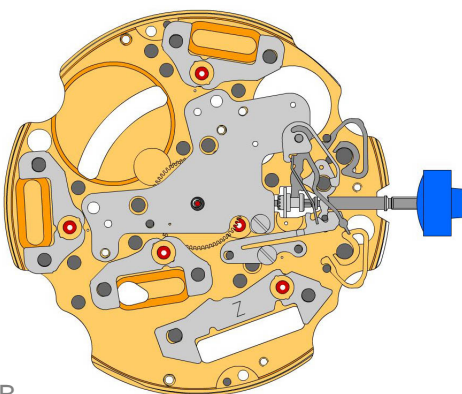









Lower working voltage limit
M2/M3/M4 **1.20 V**









A

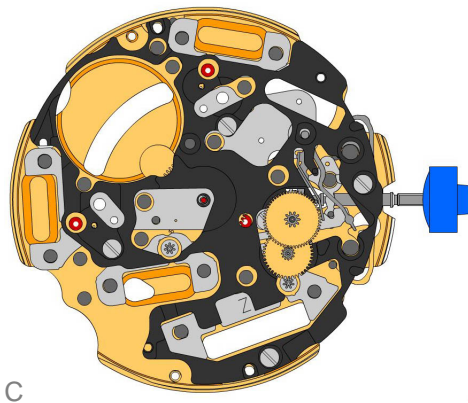





B

2000.576.G 1.		Main plate
3305.287.CO 2.		Cannon pinion with driver (Aig.3)
2030.017.CO 3.		Centre bridge Centre bridge held by 1 screw 4000.250. Parts 2030.017.CO and 3402.009.CO must be exchanged together.
4000.250 4.		Screw
3001.045 5.		Sliding pinion
3000.177.CO 6.		Setting stem
3017.049 7.		Setting lever
3905.053 8.		Setting lever jumper (2 positions) Setting lever jumper held by 1 screw 4000.250.
4000.250 9.		Screw
3015.080 10.		Yoke (2 positions)
3905.067 11.		Yoke spring
3406.030 12.		Pusher jumper B Put the grey jumper between the two posts on the further side.
3406.038 13.		Pusher jumper A Put the yellow jumper between the two posts on the closer side.
3622.040 14.		Stator Mark [Z] on stator.
3622.039 15.		Stator (counter 6h, 9h, chrono)
3622.039 16.		Stator (counter 6h, 9h, chrono)
3622.039 17.		Stator (counter 6h, 9h, chrono)

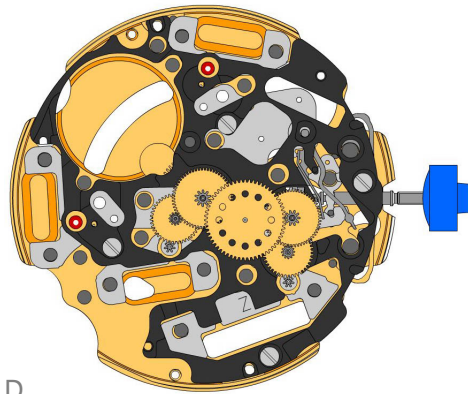



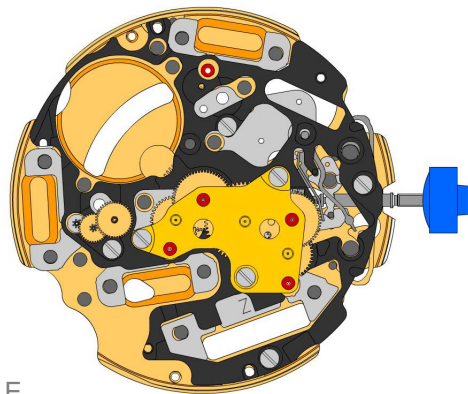

C

3603.079 18.		Plastic bracket Plastic bracket held by 4 screws 4000.250.
4000.250 19.		Screw
3715.094.RK 20.		Rotor
3715.094.RK 21.		Rotor
3147.046.CO 22.		Intermediate wheel
3136.142.CO 23.		Second wheel (long)

D





3147.047.CO 24.		Intermediate wheel (chrono)
3136.150.CO 25.		Chronograph wheel (Aig.3)
3122.056.CO 26.		Third wheel

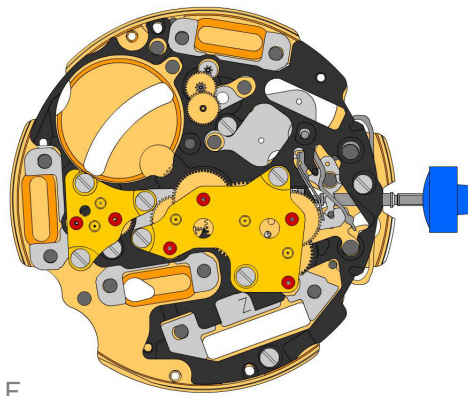

E

2020.148.G 27.		Train wheel bridge Train wheel bridge held by 3 screws 4000.250.
4000.250 28.		Screw
3715.095.RK 29.		Rotor
3147.048.CO 30.		Intermediate wheel (counter)
3402.006.CO 31.		Minute counting wheel





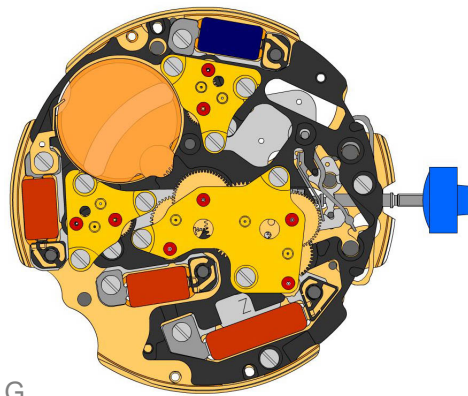







F

2020.149.G 32.		Counter train wheel bridge Counter train wheel bridge held by 3 screws 4000.250.
4000.250 33.		Screw
3715.095.RK 34.		Rotor
3147.053.CO 35.		Intermediate wheel (counter 1/10sec)
3402.009.CO 36.		Counting wheel 1/10 sec Parts 2030.017.CO and 3402.009.CO must be exchanged together.





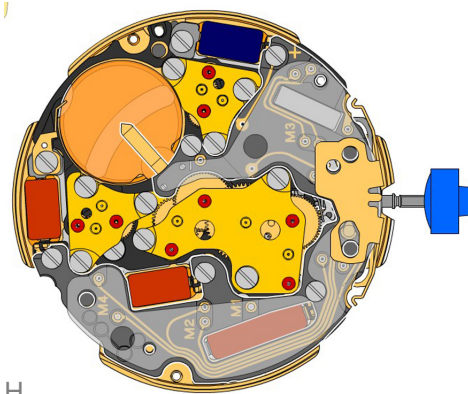

G

2020.149.G 37.		Counter train wheel bridge Counter train wheel bridge held by 3 screws 4000.250.
4000.250 38.		Screw
3621.053.RK 39.		Coil Attention: Please hold the coil only on the grey coil core. Coil held by 1 screw 4000.250.
3621.054.RK 40.		Coil (counter 9h, chrono) Attention: Please hold the coil only on the grey coil core. Coil held by 1 screw 4000.250.
3621.054.RK 41.		Coil (counter 9h, chrono) Attention: Please hold the coil only on the grey coil core. Coil held by 1 screw 4000.250.
3621.055.RK 42.		Coil (counter 6h) Attention: Please hold the coil only on the grey coil core. Coil held by 1 screw 4000.250.
4000.250 43.		Screw
3601.118 44.		Contact strip Contact strip held by 1 screw 4000.250.
4000.250 45.		Screw
3603.034 46.		Battery insulator



H

3612.144.5040 47.		Electronic module Electronic module held by 5 screws 4000.248. Electronic measurements may be realised now.
4000.248 48.		Screw
3603.069 49.		Circuit insulator
3601.107.G 50.		Pusher contact spring

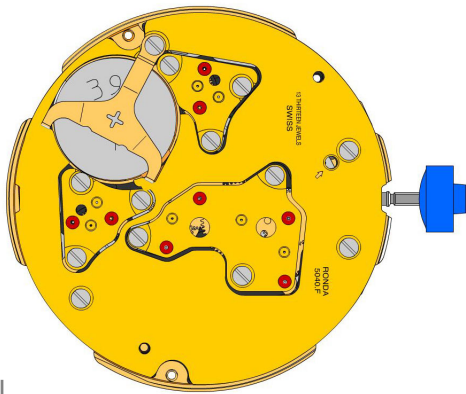





2130.137.G.M01.5040F
51.  **Electronic module cover**
Electronic module cover held by 3 screws 4000.250.

3600.010.HGF
52.  **Battery 395**

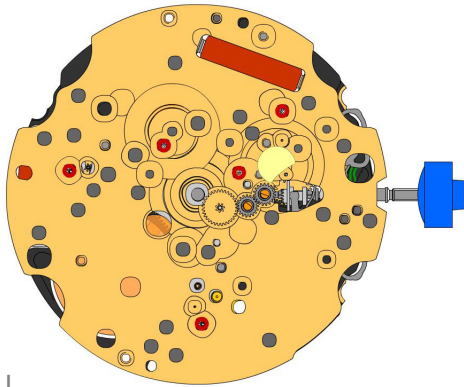



3601.109.G
53.  **Bridge +**
Bridge held by 1 screw 4000.250.

4000.250
54.  **Screw**

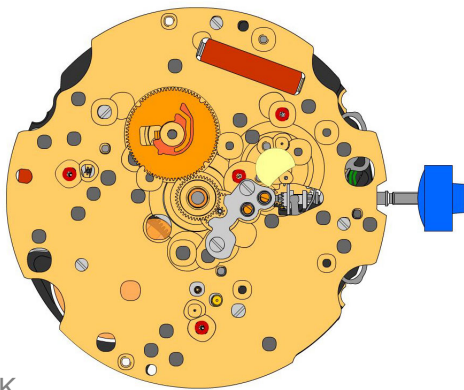



J

2000.576.G 55.		Main plate
3004.164 56.		Setting wheel
3004.164 57.		Setting wheel
3007.078.CO 58.		Minute wheel

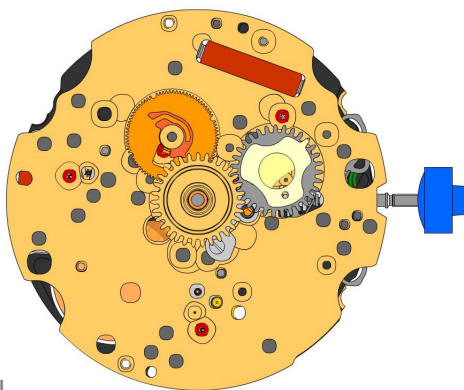







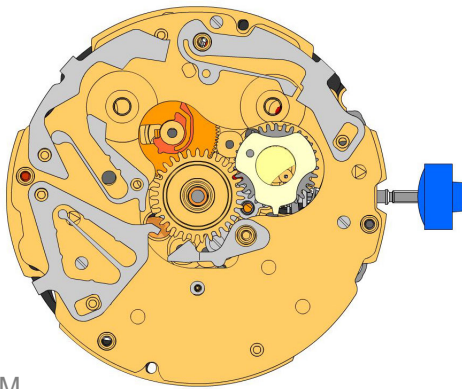
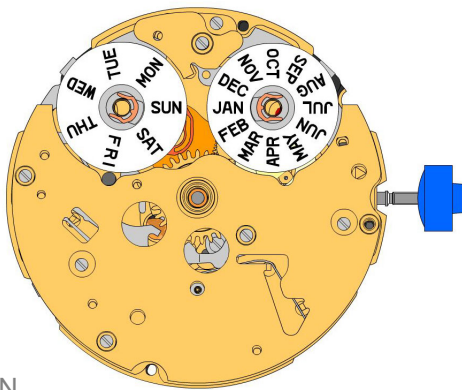







K





2130.177 59.		Minute train bridge Minute train bridge held by 4 screws 4000.319.
4000.319 60.		Screw
3301.247 61.		Hour wheel (Aig.3)
3004.171.CO 62.		Date indicator driving wheel



L

3004.173 63.		Month driving wheel
3004.174 64.		Month finger Ridges at the bottom side from the month meshed in both gaps of the month driving wheel.
3301.248 65.		Date indicator wheel

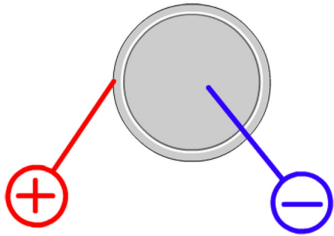

M

N

2130.155.CO 66.		Date platform Date platform held by 3 screws 4000.282.
4000.282 67.		Screw
3507.054 68.		Month corrector
3507.055 69.		Day corrector
3507.056 70.		Date corrector
3500.053 71.		Day jumper
3500.065 72.		Date jumper
2130.157.G 73.		Combined maintaining plate Combined maintaining plate held by 4 screws 4000.286.
4000.286 74.		Screw
2130.166.G 75.		Corrector maintaining plate Corrector maintaining plate held by 1 screw 4000.286.
4000.286 76.		Screw
3905.059 77.		Date jumper spring Insert the date jumper spring in the provided opening.
3508.153.AA.E.A 78.		Day indicator (standard)
3508.154.AE.E.A 79.		Month indicator (standard)
3909.028 80.		Pillar spring clip
3909.028 81.		Pillar spring clip

8200 82.		Moebius 8200
9014 83.		Moebius 9014
124 84.		Jismaa 124
9020 85.		Moebius 9020

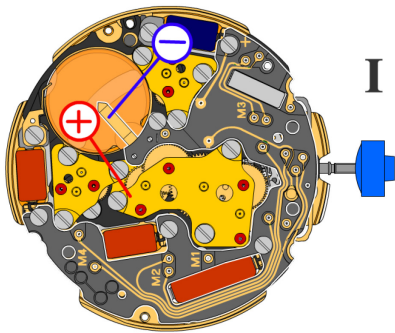

Battery	395
Voltage	1.55 V



*Setting stem in position I, calendar not in gear,
60 s measuring interval for rate and consumption:*

Typical consumption	1.32 μA
Maximal consumption	1.65 μA
Rate	-10s/M. .. +20s/M.
Lower working voltage limit	1.20 V

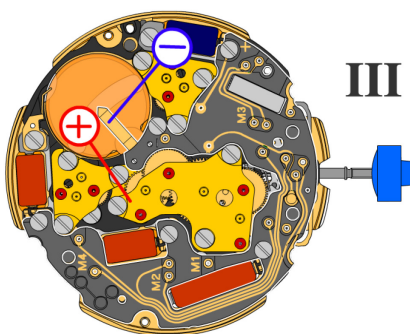

Setting stem in position III, 60 s measuring interval:

Typical consumption	0.10 μA
Maximal consumption	0.30 μA

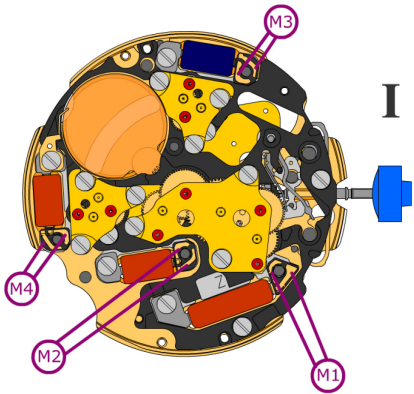

Coil resistance M1 **1.90 k Ω .. 2.10 k Ω**

Coil resistance M2 **1.68 k Ω .. 1.88 k Ω**

Coil resistance M3 **1.68 k Ω .. 1.88 k Ω**

Coil resistance M4 **1.68 k Ω .. 1.88 k Ω**

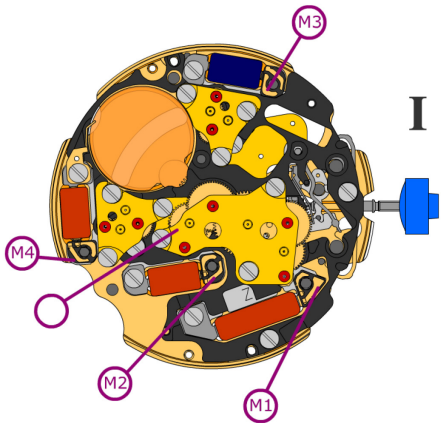

Coil isolation M1/M2/M3/M4 **∞ k Ω**

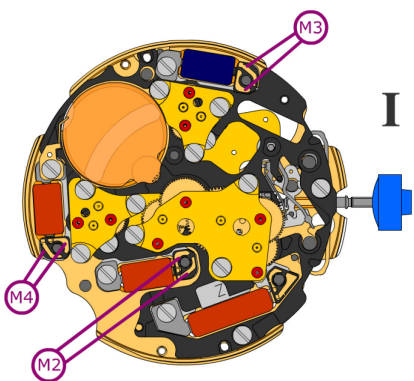

Signal generator (4.9 ms, 8 Hz):



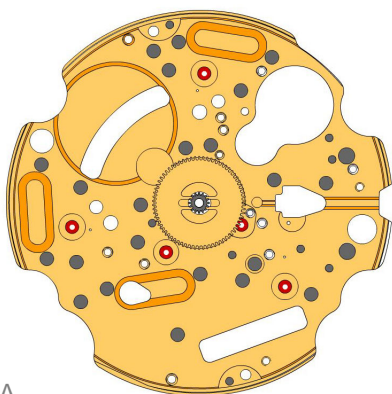



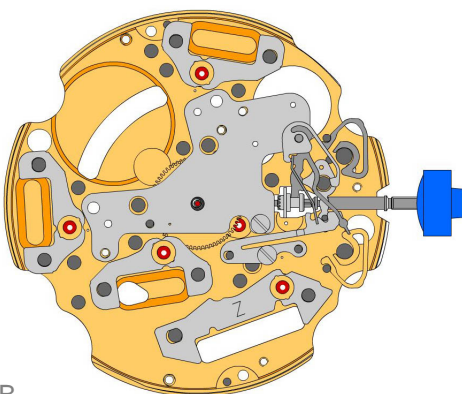









Lower working voltage limit M2/M3/M4 **1.20 V**





A

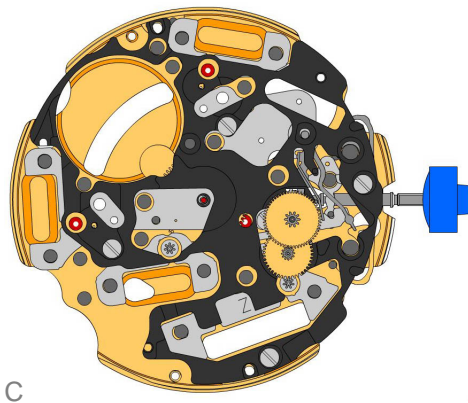

B

2000.576.G 1.		Main plate
3305.287.CO 2.		Cannon pinion with driver (Aig.3)
2030.039.CO 3.		Centre bridge Centre bridge held by 1 screw 4000.250.
4000.250 4.		Screw
3001.045 5.		Sliding pinion
3000.177.CO 6.		Setting stem
3017.049 7.		Setting lever
3905.053 8.		Setting lever jumper (2 positions) Setting lever jumper held by 1 screw 4000.250.
4000.250 9.		Screw
3015.080 10.		Yoke (2 positions)
3905.067 11.		Yoke spring Tensioning the spring arm.
3406.030 12.		Pusher jumper B Put the grey jumper between the two posts on the further side.
3406.038 13.		Pusher jumper A Put the yellow jumper between the two posts on the closer side.
3622.040 14.		Stator Mark [Z] on stator.
3622.039 15.		Stator (counter 6h, 9h, chrono)
3622.039 16.		Stator (counter 6h, 9h, chrono)
3622.039 17.		Stator (counter 6h, 9h, chrono)



3603.079
18.  **Plastic bracket**
Plastic bracket held by 4 screws 4000.250.

4000.250
19.  **Screw**

3715.094.RK
20.  **Rotor**

3715.094.RK
21.  **Rotor**

3147.046.CO
22.  **Intermediate wheel**

3136.142.CO
23.  **Second wheel (long)**

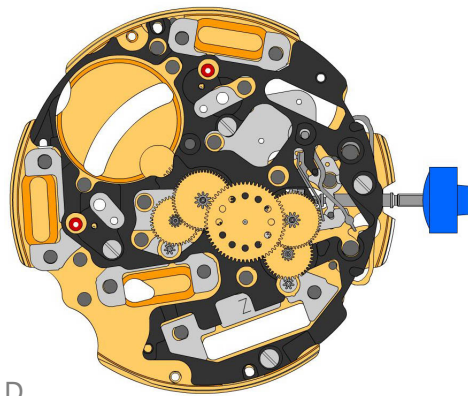

3147.047.CO
24.  **Intermediate wheel (chrono)**

3136.150.CO
25.  **Chronograph wheel (Aig.3)**

3122.056.CO
26.  **Third wheel**

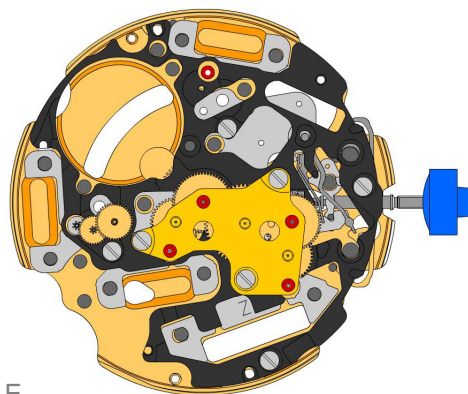

2020.148.G
27.  **Train wheel bridge**
Train wheel bridge held by 3 screws 4000.250.





4000.250
28.  **Screw**

3715.095.RK
29.  **Rotor**

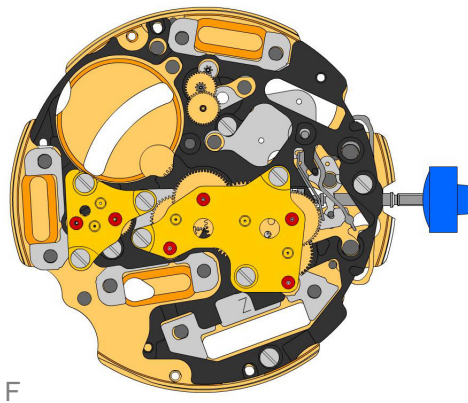



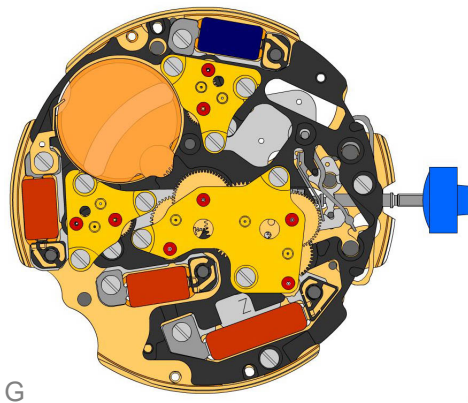

3147.048.CO
30.  **Intermediate wheel (counter)**

3402.006.CO
31.  **Minute counting wheel**









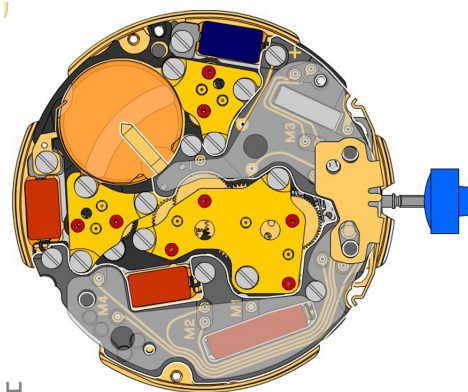

2020.149.G 32.		Counter train wheel bridge Counter train wheel bridge held by 3 screws 4000.250.
4000.250 33.		Screw
3715.095.RK 34.		Rotor
3147.053.CO 35.		Intermediate wheel (counter 1/10sec)
3402.016.CO 36.		Counting wheel 1/10 sec







2020.149.G 37.		Counter train wheel bridge Counter train wheel bridge held by 3 screws 4000.250.
4000.250 38.		Screw
3621.053.RK 39.		Coil Attention: Please hold the coil only on the grey coil core. Coil held by 1 screw 4000.250.
3621.054.RK 40.		Coil (counter 9h, chrono) Attention: Please hold the coil only on the grey coil core. Coil held by 1 screw 4000.250.
3621.054.RK 41.		Coil (counter 9h, chrono) Attention: Please hold the coil only on the grey coil core. Coil held by 1 screw 4000.250.
3621.055.RK 42.		Coil (counter 6h) Attention: Please hold the coil only on the grey coil core. Coil held by 1 screw 4000.250.

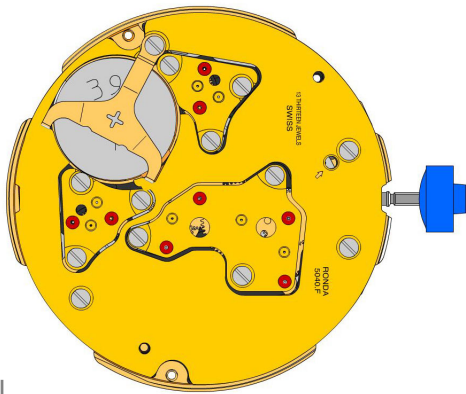

4000.250 43.		Screw
3601.118 44.		Contact strip Contact strip held by 1 screw 4000.250.
4000.250 45.		Screw
3603.034 46.		Battery insulator





3612.144.5040 47.		Electronic module Electronic module held by 5 screws 4000.248. Electronic measurements may be realised now.
4000.248 48.		Screw
3603.069 49.		Circuit insulator
3601.107.G 50.		Pusher contact spring

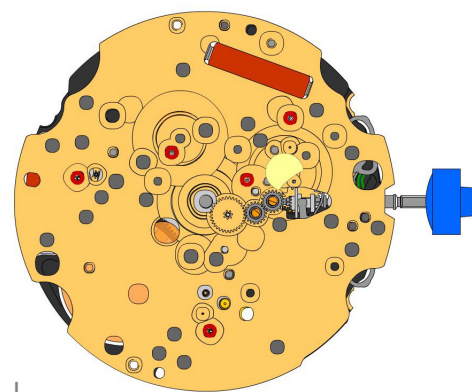

2130.137.G.M01.5040F 51.		Electronic module cover Electronic module cover held by 3 screws 4000.250.
3600.010.HGF 52.		Battery 395
3601.109.G 53.		Bridge + Bridle held by 1 screw 4000.250.
4000.250 54.		Screw





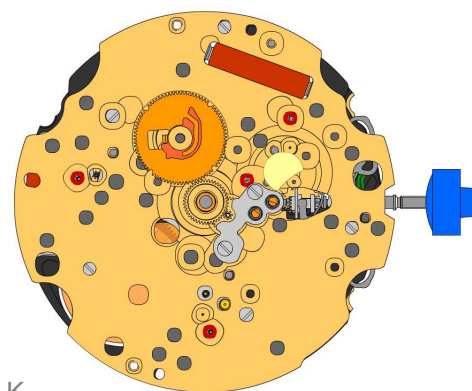

J

2000.576.G 55.		Main plate
3004.164 56.		Setting wheel
3004.164 57.		Setting wheel
3007.078.CO 58.		Minute wheel





K

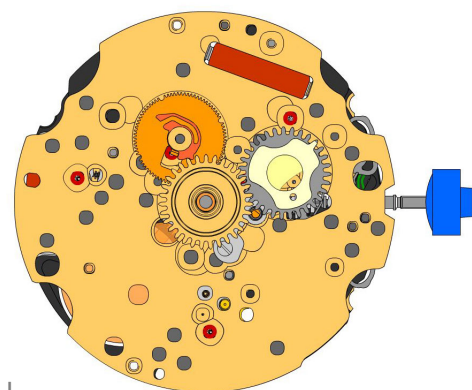







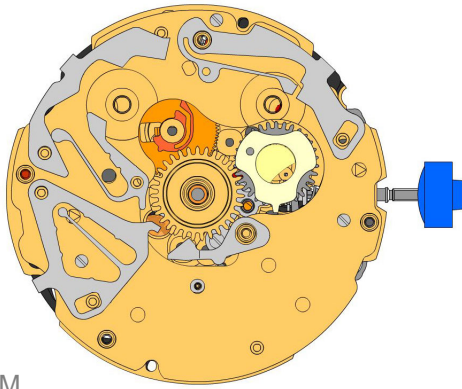
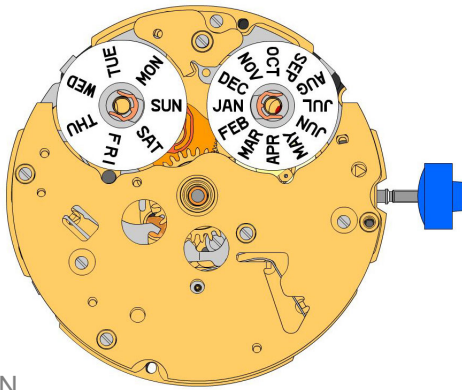







2130.177 59.		Minute train bridge Minute train bridge held by 4 screws 4000.319.
4000.319 60.		Screw
3301.247 61.		Hour wheel (Aig.3)
3004.171.CO 62.		Date indicator driving wheel







L

3004.173 63.		Month driving wheel
3004.174 64.		Month finger Ridges at the bottom side from the month meshed in both gaps of the month driving wheel.
3301.248 65.		Date indicator wheel



M

N

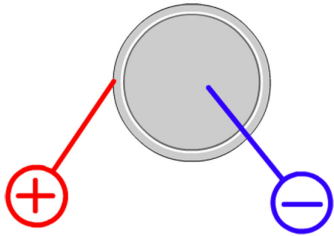
2130.155.CO 66.		Date platform Date platform held by 3 screws 4000.282.
4000.282 67.		Screw
3507.054 68.		Month corrector
3507.055 69.		Day corrector
3507.056 70.		Date corrector
3500.053 71.		Day jumper
3500.065 72.		Date jumper
2130.157.G 73.		Combined maintaining plate Combined maintaining plate held by 4 screws 4000.286.
4000.286 74.		Screw
2130.166.G 75.		Corrector maintaining plate Corrector maintaining plate held by 1 screw 4000.286.
4000.286 76.		Screw
3905.059 77.		Date jumper spring Insert the date jumper spring in the provided opening.
3508.153.AA.E.A 78.		Day indicator (standard)
3508.154.AE.E.A 79.		Month indicator (standard)
3909.028 80.		Pillar spring clip
3909.028 81.		Pillar spring clip

8200 82.		Moebius 8200
9014 83.		Moebius 9014
124 84.		Jismaa 124
9020 85.		Moebius 9020

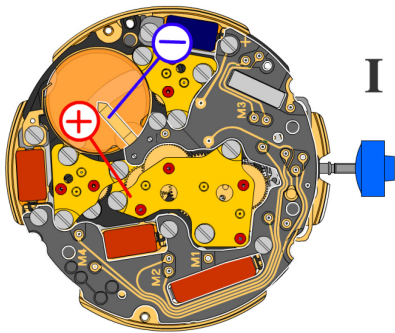

Battery	395
Voltage	1.55 V



*Setting stem in position I, calendar not in gear,
60 s measuring interval for rate and consumption:*

Typical consumption	1.32 μA
Maximal consumption	1.65 μA
Rate	-10s/M. .. +20s/M.
Lower working voltage limit	1.20 V

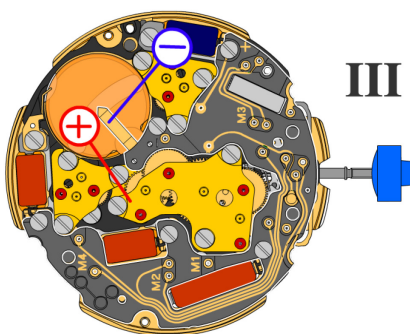

Setting stem in position III, 60 s measuring interval:

Typical consumption	0.10 μA
Maximal consumption	0.30 μA

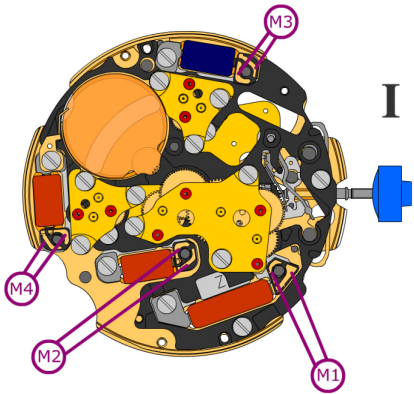

Coil resistance M1 **1.90 k Ω .. 2.10 k Ω**

Coil resistance M2 **1.68 k Ω .. 1.88 k Ω**

Coil resistance M3 **1.68 k Ω .. 1.88 k Ω**

Coil resistance M4 **1.68 k Ω .. 1.88 k Ω**

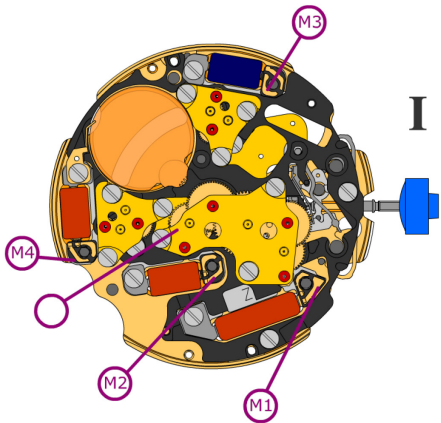

Coil isolation M1/M2/M3/M4 **∞ k Ω**

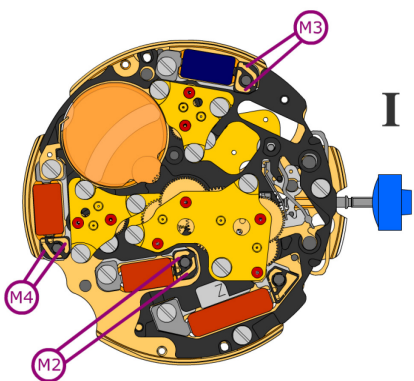

Signal generator (4.9 ms, 8 Hz):

Lower working voltage limit M2/M3/M4 **1.20 V**