

TECHNICAL GUIDE
&
PARTS CATALOGUE

Cal.VD3 Series
(VD33B/34B)



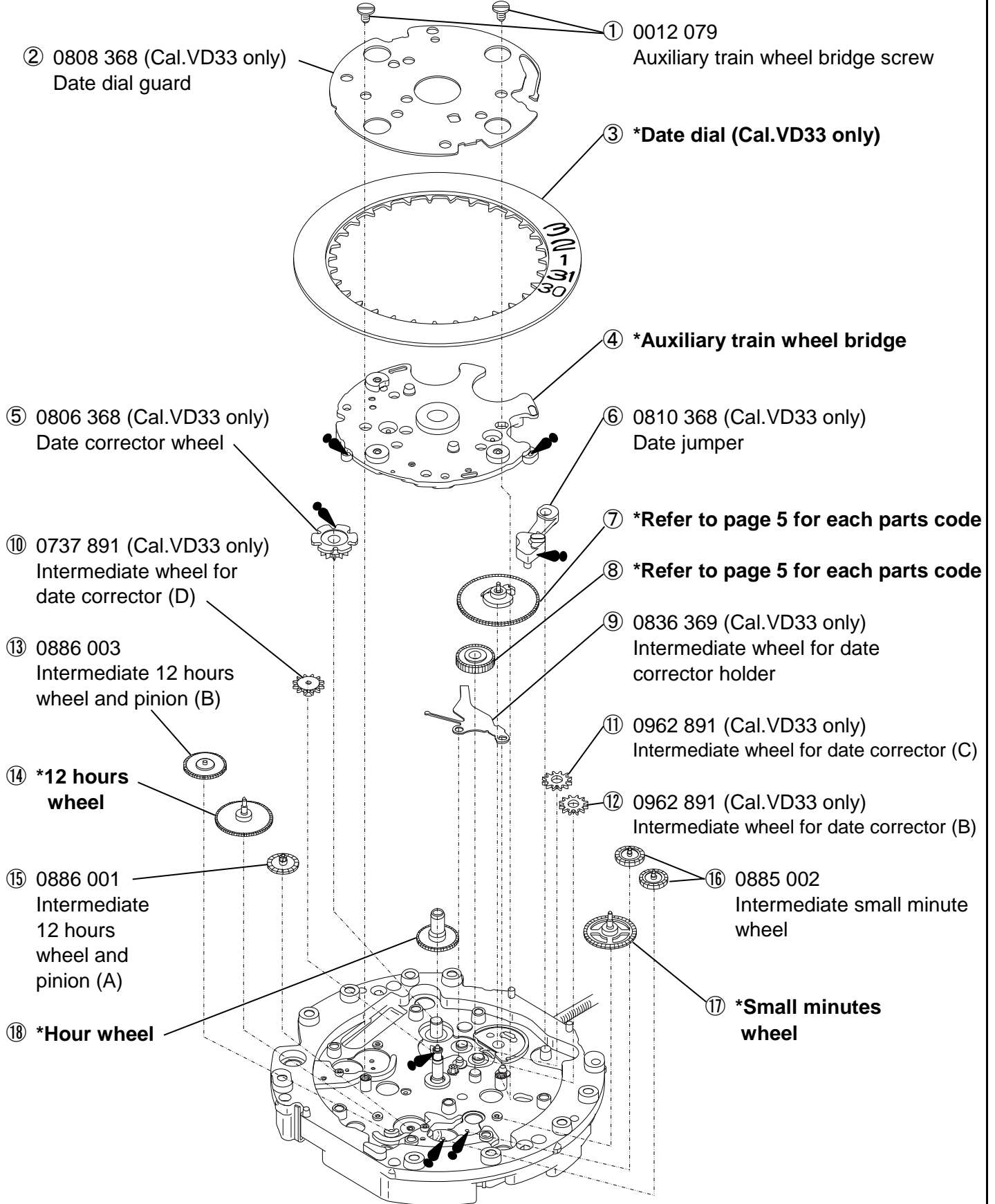

ANALOGUE QUARTZ

Item		Cal. No.	VD33B	VD34B
Movement				
Movement size	Outside diameter	φ29.50 mm × 26.00 mm (3H-9H)		
	Casing diameter	φ28.80 mm		
	Total height	4.57 mm	3.97 mm	
Time indication			3 Hands (Hour, Minute, Second) Dual time of 12 hour regulator hand Dual time of 60 minute regulator hand 24 hour hand, Calendar	3 Hands (Hour, Minute, Second) Dual time of 12 hour regulator hand Dual time of 60 minute regulator hand
Driving system		Two pole stepping motor Step motor 2 pieces		
Additional mechanism			Electronic circuit reset switch Second setting device Date setting Time difference correction	Electronic circuit reset switch Second setting device Time difference correction
Antimagnetic		≥ 1600 A/m		
Accuracy		Less than ± 20 seconds : Monthly rate at normal temperature range		
Battery		SR920SW (Silver oxide battery) Battery life is approximately 3 years		
Measuring gate by quartz tester		Use 10 second gate *Set the winding stem with crown at the normal position		
Jewels		0 Jewel		
Crown position	Normal position		Free	Free
	First click	Left rotation	Free	Time setting with stop-second device
		Right rotation	Date setting	
Second click		Time setting with stop-second device		-
Buttons	Button A		- 1 hour / push Time difference correction	
	Button B		+ 1 hour / push Time difference correction	





Disassembling procedures Figs. ① → ④⑤	Lubricating : Types of oil	Oil quantity
Reassembling procedures Figs. ④⑤ → ①	●● Moebius 9010	○● NORMAL QUANTITY
	■● Moebius 9030	
	●● S-6	

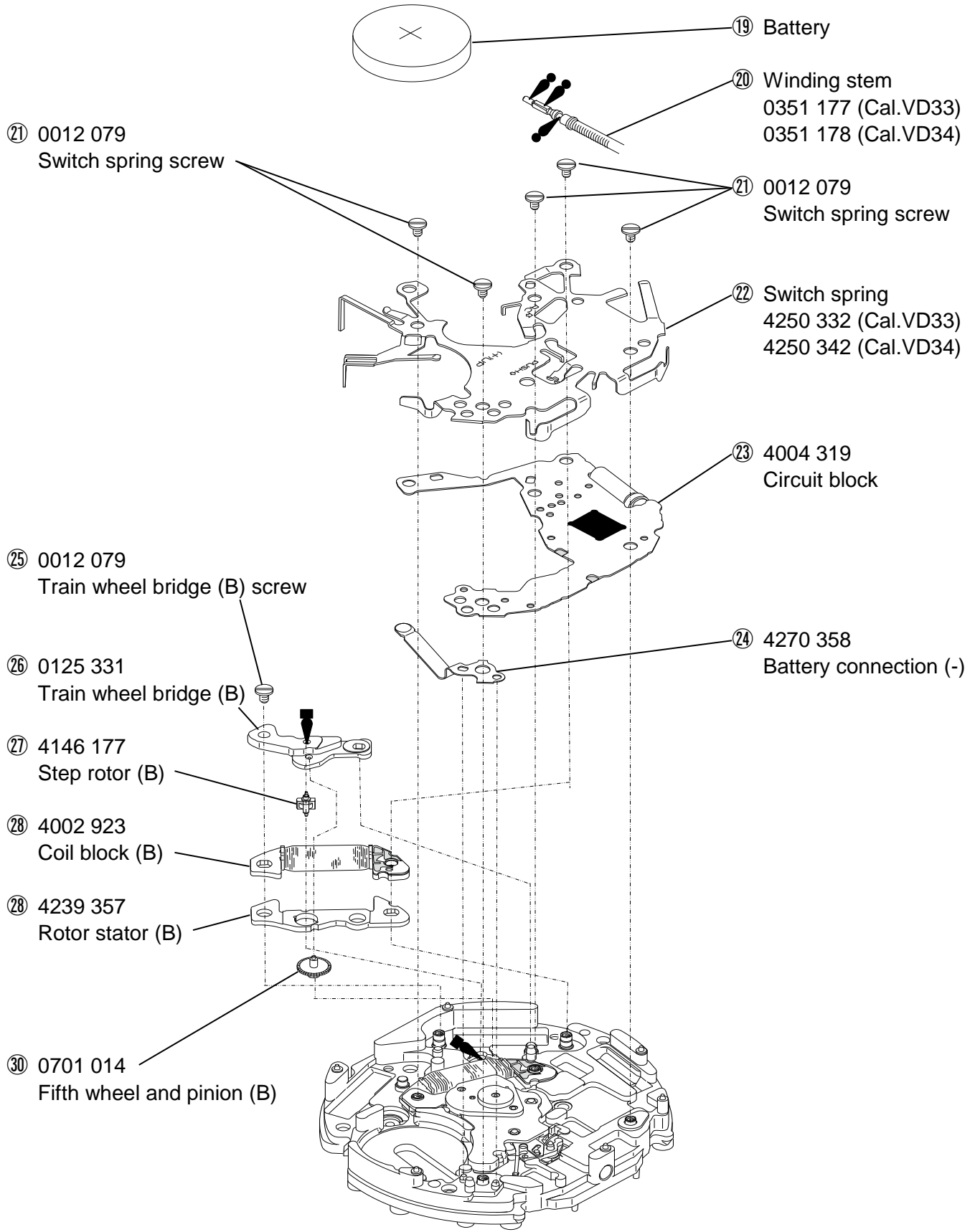

*Refer to page 5 for each parts code

Disassembling procedures Figs. ① → ④⑤ Reassembling procedures Figs. ④⑤ → ①	Lubricating : Types of oil	Oil quantity
	 Moebius 9010  Moebius 9030  S-6	 NORMAL QUANTITY



Disassembling procedures Figs. ① → ④⑤	Lubricating : Types of oil	Oil quantity
Reassembling procedures Figs. ④⑤ → ①	 Moebius 9010  Moebius 9030  S-6	 NORMAL QUANTITY

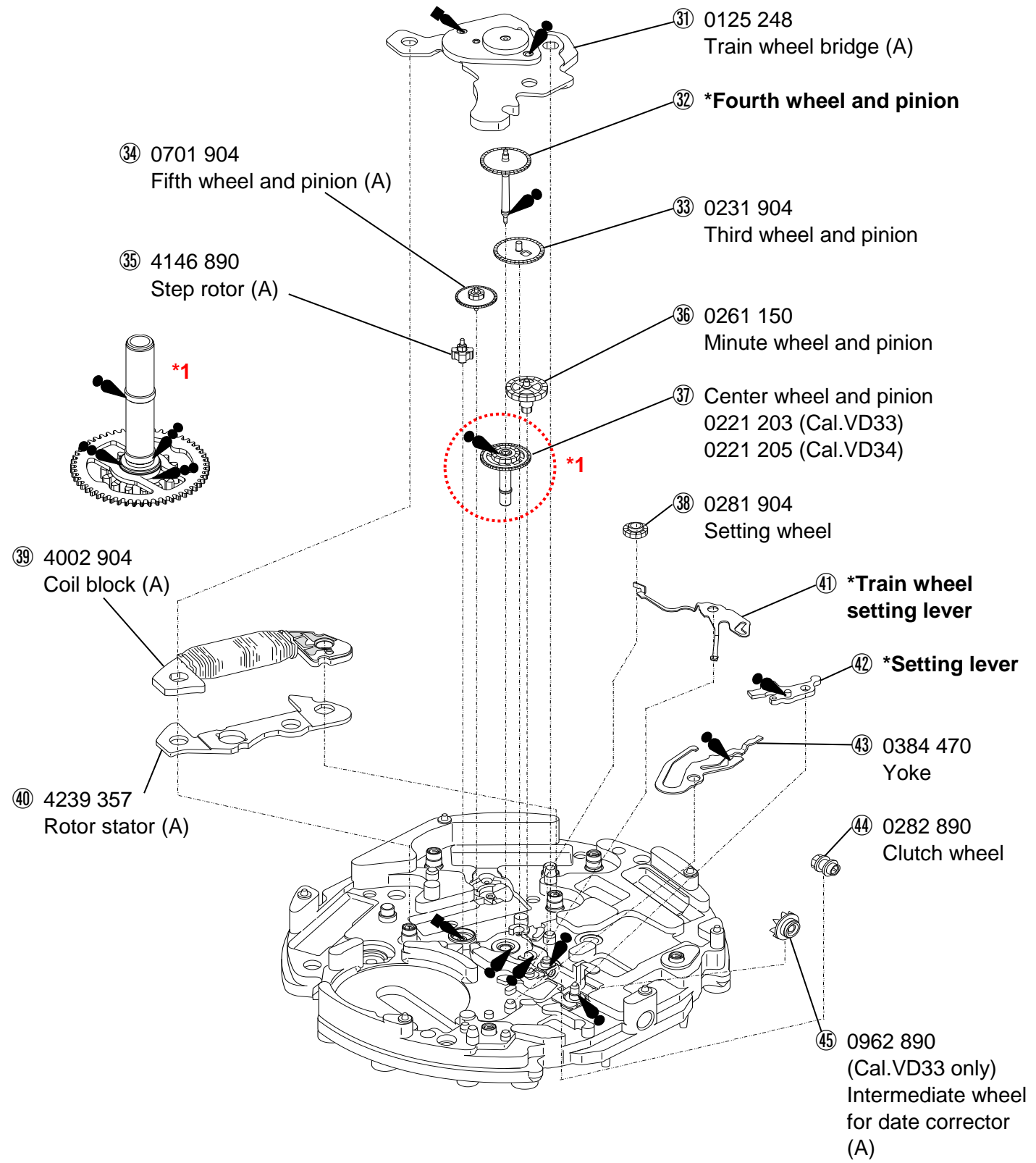

*Refer to page 5 for each parts code

Remarks:

③ Date dial (Cal.VD33 only)

Part code	Position of crown	Position of date frame	Color of figure	Color of background
0878 220	3H	3H	Black	White
0878 221	3H	3H	White	Black

Page	No	Parts name	Parts code VD33	Parts form	Parts code VD34	Parts form
2	④	Auxiliary train wheel bridge	0126 368		0126 357	
	⑦	Small hour hand wheel (Cal.VD33)	0157 006		0157 130	
		24 hour hand wheel (Cal.VD34)				
	⑧	Intermediate date driving wheel (Cal.VD33)	0817 368		0817 357	
		Intermediate small hour hand wheel (Cal.VD34)				
	⑭	12 hours wheel	0902 016		0902 015	
	⑰	Small minutes wheel	0888 014		0888 013	
⑱	Hour wheel	0271 407		0271 406		
4	⑳	Fourth wheel and pinion	0241 178		0241 177	
	㉑	Train wheel setting lever	0391 368		0391 357	
	㉒	Setting lever	0383 368		0383 470	

***All parts code are subject to change without notice.**

•The explanation here is only for the particular point of Cal.VD33&VD34

1.REMARKS ON INSTALLING THE BATTERY

(1) Battery

•How to install the battery

- ① Remove the hook of the switch springs battery clamp portion.
- ② Insert the battery sideways, and have the hook of the switch springs battery clamp portion catch the main plate.

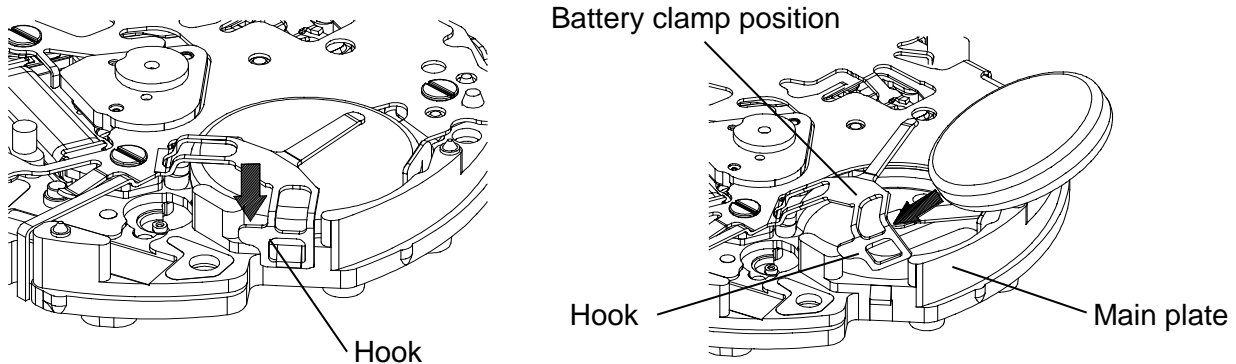

- (2) After the battery is replaced with a new one or after the battery is reinstalled following the repairing procedures, Be sure to touch the short-circuit the AC terminal of circuit block and the switch spring with conductive tweezers to reset the circuit as illustrated at right.

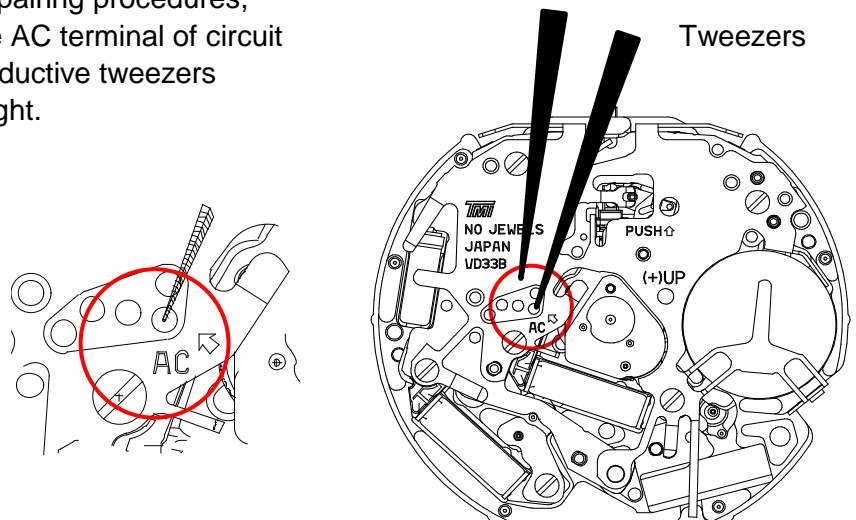

- (3) When the battery replaced with a new one, the time information stored in the built-in IC and the time indicated by the dual time of 12 hour regulator and dual time of 60 minute regulator hands do not correspond with each other.
Reset the dual time of 12 hour regulator and dual time of 60 minute regulator hands to "0" position following the procedure below.
If the dual time of 12 hour regulator and dual time of 60 minute regulator hands should move improperly, also follow the same procedure.

Note

Refer to page 8 for each adjustment method.

2.To remove the winding stem

- (1) set the winding stem to normal position.
- (2) While pushing the indented portion of the arrow, pull out the winding stem.

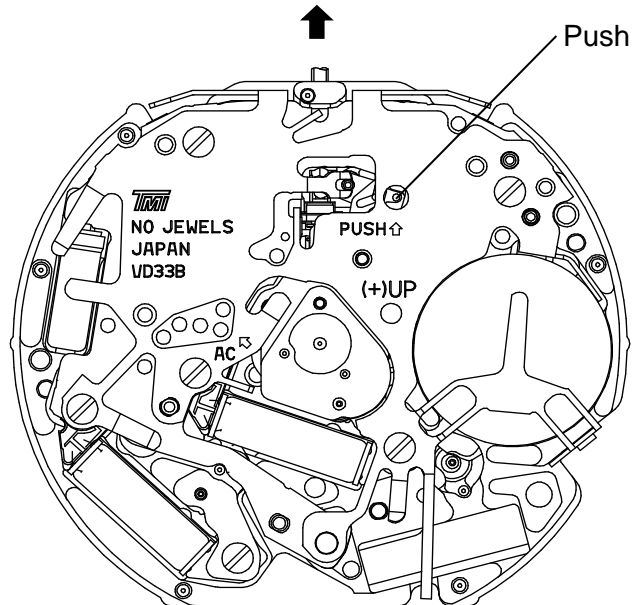

3.How to attach hands

Please put on the metal plate so as to avoid 6 protrusions.(Right figure:place of red circle)

- *Install the hour, minute and second hands at the "12" o'clock position.
- *Install the 24 hour indicator at the "24" position.
- *Install the dual time of 12 hour regulator and dual time of 60 minute regulator hands at the "12" and "60" position respectively.

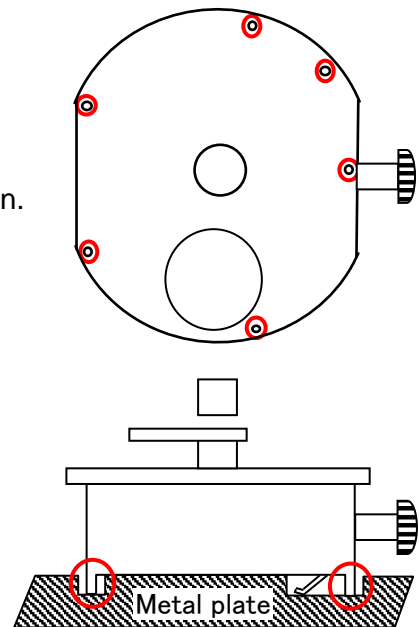

[Reference] The power of press hands

Minute & Hour Hands	< 5kg
Second Hand	< 5kg
24 hour indicator	< 3kg
Dual time of 12 hour regulator hand	< 3kg
Dual time of 60 minute regulator hand	< 3kg

DISPLAY AND CROWN / BUTTON OPERATION

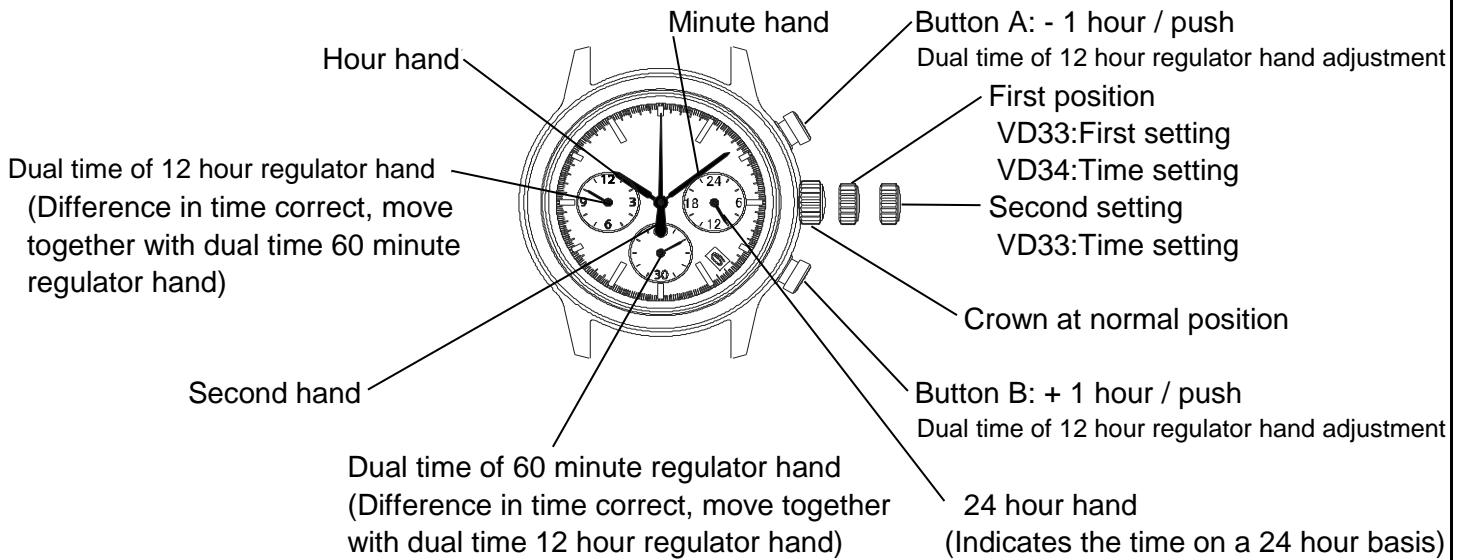

Note

*Dual time of 60 minute regulator hand rotates one revolution every 15 minute.
There is no problem because this is typical function.

ADJUSTING THE DUAL TIME OF 12 HOUR REGULATOR AND DUAL TIME OF 60 MINUTE REGULATOR HANDS POSITION

Before setting the time, check if the dual time of 12 hour regulator and dual time of 60 minute regulator hands are in the "0" (12 o'clock) position.

If either of the dual time of 12 hour regulator and dual time of 60 minute regulator hands are not in the "0" position, reset them following the procedure below.

The battery setting and after battery change, please execute the "0" position adjustment.

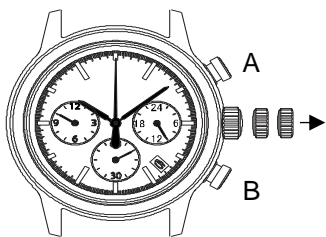

- 1.Pull out the crown.
VD33:second click
VD34:first click

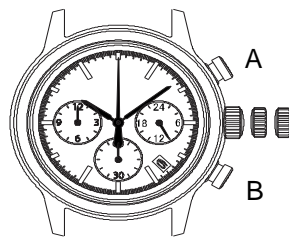

- 2.Keep the buttons A & B pressed at the same time more than 2 seconds, and then release the buttons.
*Dual time of 60 minute regulator hand moves. Returned to where it was.

- 3.Press button A or B to reset the dual time of 12 hour regulator and dual time of 60 minute regulator hands to "0" position.

*By pressing button A the hands move counter clockwise.
*By pressing button B the hands move clockwise.
*Press and hold the button, possible to fast-forward modification.
*Dual time of 12 hour regulator hand are linked to dual time of 60 minute regulator hand.

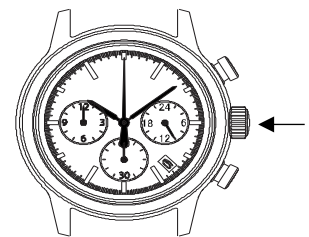

- 4.Push the crown back to the normal position.

Note

Please repeat above 4 steps, as 0 position adjustment, if the dual time of 60 minute regulator hand moves as follows;

Up to 1 minute to 14 minutes, one step / push, in 15 minutes, repeat the one rotation / push

TIME SETTING

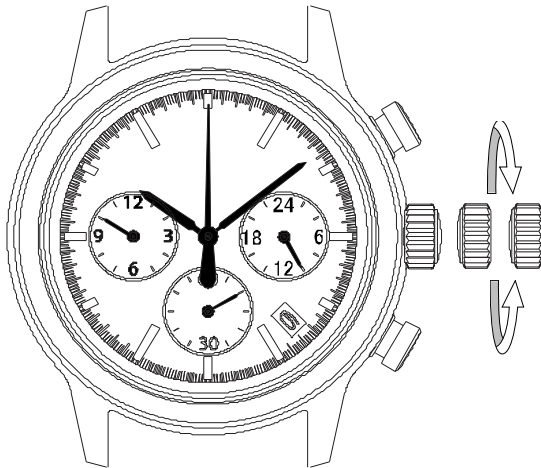

1. Pull out the crown when the second hand is at the 12 o'clock position.
[Crown position]
VD33: Second click
VD34: First click
2. Turn the crown to set the hour and minute hands.
(Check that 24 hour hand is set correctly)
3. Push the crown back normal position in accordance with a time signal.

Note

- *The 24 hour hand moves correspondingly with the hour hand.
- *The moment the date changes is midnight. When setting the hour hand, make sure that AM/PM is correctly set by using the 24 hour hand as an AM/PM indicator.
- *At the time of carrying, dual time of 60 minute regulator hand rotates one revolution every 15 minutes. There is no problem because this is typical function.

■ Using the time different correction

When moving to a country or area which is in a different timezone, the current time in the local time can be corrected.

1. Crown the normal position.
2. To adjust the time by pressing the button A or B.
 - *By pressing button A the hands move counter clockwise. - 1 hour / push
 - *By pressing button B the hands move clockwise. + 1 hour / push

TIME SETTING (DUAL TIME OF 12 HOUR REGULATOR AND DUAL TIME OF 60 MINUTE REGULATOR HANDS)

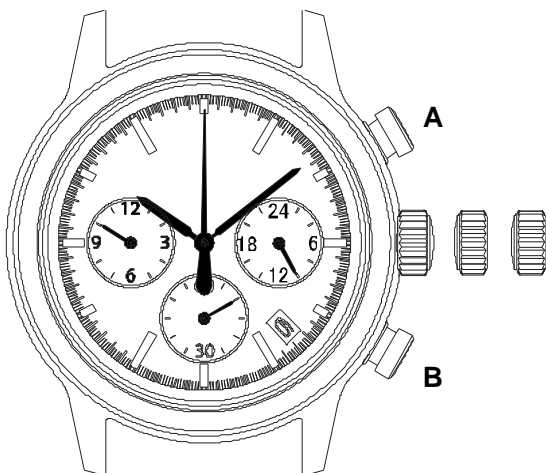

1. Pull out the crown when the second hand is at the 12 o'clock position.
[Crown position]
VD33: Second click
VD34: First click
2. To adjust the time by pressing the buttons A or B.
By pressing button A the hands move counter clockwise.
By pressing button B the hands move clockwise.
*Press and hold the button, possible to fast-forward modification.
3. Push the crown back in to the normal position.

Note

Every 15 minutes, dual time of 60 minute hand is one rotation / push.

DATE SETTING (Cal.VD33 only)

*Before setting the date, be sure to set the time.

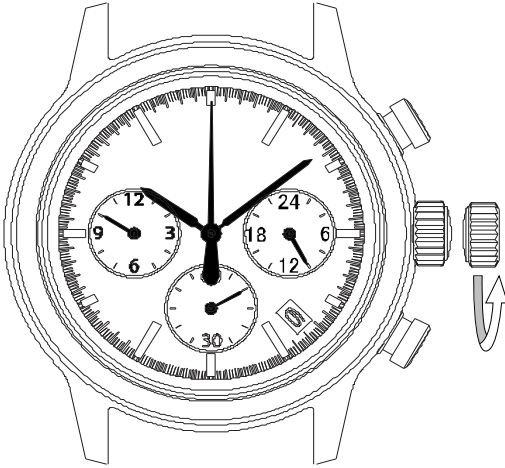

1. Pull out the crown to the first click.
2. Turn the crown to clockwise until the next date appears.
3. Push the crown back in to the normal position.

Note

*Do not set the date during any time between 9:00 P.M. and 1:00 A.M.

Otherwise, the date may not change properly. If it is necessary to set the date during that time period, First change the time to any time outside it, set the date and then reset the correct time.